

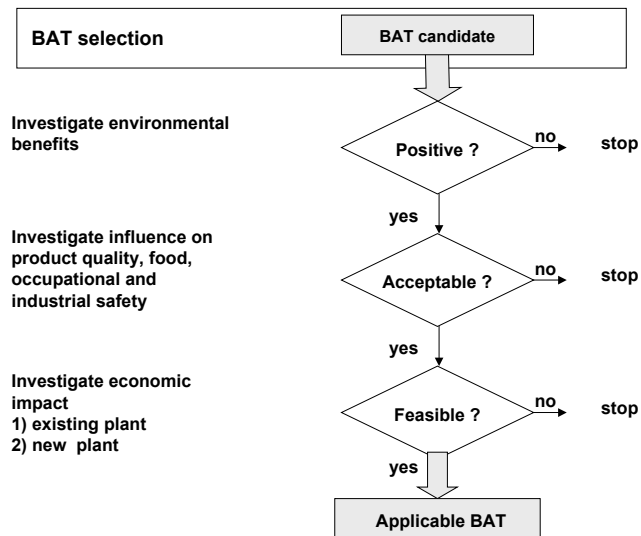

# The Brewers of Europe

## Guidance Note for establishing BAT in the brewing industry



October 2002

## TABLE OF CONTENTS

<b>1. Introduction .....</b>	<b>3</b>
1.1 Background.....	3
1.2 Demarcation of the Guidance Note.....	5
<b>2. Description of the Brewing Processes .....</b>	<b>7</b>
2.1 Production Processes.....	7
2.1.1 Wort Production.....	7
2.1.2 Fermentation / Beer Processing Area.....	12
2.1.3 Packaging.....	17
2.2 Beer Types.....	23
2.3 Utilities.....	23
2.4 Business Processes .....	25
<b>3. Environmental Impact.....</b>	<b>27</b>
3.1 Type of Environmental Impact .....	27
3.2 Geographical Impact .....	28
3.2.1 Global.....	28
3.2.2 Regional .....	28
3.2.3 Local.....	29
3.2.4 General .....	30
<b>4. Resource Consumption and Emissions.....</b>	<b>31</b>
4.1 Global.....	31
4.1.1 Energy Production and Consumption.....	31
4.1.2 Production synergies.....	31
4.2 Regional .....	34
4.2.1 Water.....	34
4.2.2 Wastewater.....	35
4.2.3 Solid Waste .....	37
4.3 Local .....	39
4.3.1 Noise .....	39
4.3.2 Odour.....	40
4.3.3 Dust.....	40
4.3.4 Risk Activities.....	41
4.4 General.....	41
4.4.1 Utilisation of Raw Materials.....	41
4.5 Typical Resource Consumption .....	41
<b>5. Best Available Techniques.....</b>	<b>43</b>
5.1 Energy.....	44
5.1.1 Selection of Priorities .....	44
5.1.2 Potential BAT's .....	45
5.2 Water.....	53
5.2.1 Selection of Priorities .....	53
5.2.2 Potential BAT's .....	53

5.3	Wastewater .....	57
5.3.1	Selection of Priorities .....	57
5.3.2	Potential BAT's .....	57
5.4	Solid Waste .....	61
5.4.1	Selection of Priorities .....	61
5.4.2	Potential BAT's .....	61
5.5	Noise .....	62
5.5.1	Selection of Priorities .....	62
5.6	Odour .....	62
5.6.1	Selection of Priorities .....	62
5.6.2	Potential BAT's .....	62
5.7	Dust .....	62
5.7.1	Selection of Priorities .....	62
5.7.2	Potential BAT's .....	63
5.8	Risk Activities .....	63
5.8.1	Selection of Priorities .....	63
5.8.2	Potential BAT's .....	63
5.9	Raw Materials .....	64
5.9.1	Selection of Priorities .....	64
5.9.2	Potential BAT's .....	64
5.9.3	Yeast .....	65
5.9.4	Residual Beer .....	66
5.9.5	Table of Other Potential BAT's .....	67
<b>6.</b>	<b>End of Pipe Techniques .....</b>	<b>68</b>
6.1	Energy .....	68
6.2	Water .....	68
6.3	Wastewater Treatment .....	68
6.3.1	Characteristics of Brewery Wastewater .....	69
6.3.2	Pre-treatment .....	70
6.3.3	Anaerobic Treatment .....	71
6.3.4	Aerobic Treatment .....	72
6.4	Solid Waste Handling .....	73
6.5	Noise .....	74
6.6	Odour .....	75
6.7	Dust .....	75
6.8	Risk Activities .....	75
<b>7.</b>	<b>Cross Reference to "BREF" .....</b>	<b>76</b>
<b>8.</b>	<b>References .....</b>	<b>78</b>

## **1. Introduction**

### **1.1 Background**

In 1996 The European Union approved the Integrated Pollution Prevention and Control Directive (IPPC Directive 96/61/EC) and in order to facilitate the implementation of the directive, the EU established the European IPPC Bureau (EIPPCB). The objective of the Bureau was to catalyse an exchange of technical information on Best Available Techniques (BAT) among industries in general and to create reference documents (BREFs) to be taken into account when the competent authorities of Member States determine conditions for IPPC permits for their industry.

Based on the generic definition “treatment and processing plants for production of food products from vegetable matter with a production capacity of more than 300 tons of finished product per day (mean value over a quarter of a year)”, the directive is also applicable for medium sized and large breweries (from approx. 1 mill hl per annum).

From a historical point of view breweries have always been interested in the protection of the environment as sufficient supply of water with a good quality traditionally has been essential for the brewers. Good water quality has a positive influence on the taste of the beer and water is necessary to raise steam to clean the production equipment.

Product safety is of the greatest importance as beer is a food product consumed by humans. It is vital for the breweries to be able to secure safe products to their consumers. In order to meet this requirement it is important that the breweries can ensure a good hygienic standard throughout the entire production process. This will inevitably lead to the utilisation of energy, water and chemicals with subsequent discharge of combustion gases and wastewater.

The term “brewery” does - when viewing the European brewing industry - cover an industrial sector of great variability.

A large number of different beers varying in the use of raw material, strength, taste profile and packing can be found on the markets in Europe. The Lager or Pilsner is largest in quantity, but many others such as Ale, Stout, Porter, wheat beer, etc. have significant shares of the various markets within Europe. The spectrum of products, i.e. the beer types and the containers into which the beer is filled, depends on the market requirements and national legislation e.g. German Purity Law. Every brewery has its own, very specific product and container mix. The production methods for the products vary and will,

therefore have different effect on the production processes and naturally, this results in widely different environmental impacts.

The location of the brewery is bound to influence the environmental relevance of different impacts. A brewery located within a city must be viewed differently from a brewery located in the countryside. In relation to this the age of a brewery, its historical development and the large capital investment, which has been made in the production equipment, are relevant issues to consider when evaluating the opportunities for BAT implementation.

The scale of production influences the feasibility based on economic, technical and organisational reasons to implement BAT's and therefore due consideration must be taken.

As a part of the Food and Drink industry CBMC - The Brewers of Europe, a Member of the CIAA<sup>1</sup> has participated actively in the process of preparing the Food, Drink and Milk BREF. By this "Guidance Note for establishing BAT in the brewing industry", CBMC wishes to contribute further to the understanding of the European Brewing industry and its socio-economic impact, of the brewing process and its environmental dimensions as well as the possibilities for establishing BAT.

The objective of this document is to contribute to the preparation of the BREF with a view to serving as a practical reference for use by authorities as well as breweries particularly when preparing IPPC permits for breweries.

The Guidance Note describes the production of beer and the environmental impact generated seen from a global, regional and local perspective. The different sources causing the impact are identified and possible BAT's and "End of Pipe Techniques" relevant for the brewing industry are discussed. In order to facilitate the integration into the BREF, a cross-reference to the BREF's second draft is included.

On behalf of CBMC the company Danbrew Ltd. A/S has outlined the Guidance Note based upon CBMC member contributions. The Guidance Note has been commented and endorsed by the CBMC BAT working group. The CBMC member contributions are among the references.

---

<sup>1</sup> Confederation of the Food & Drink Industries of the EU

## 1.2 Demarcation of the Guidance Note

The supply chain for the beer production is illustrated in Fig. 1.1.

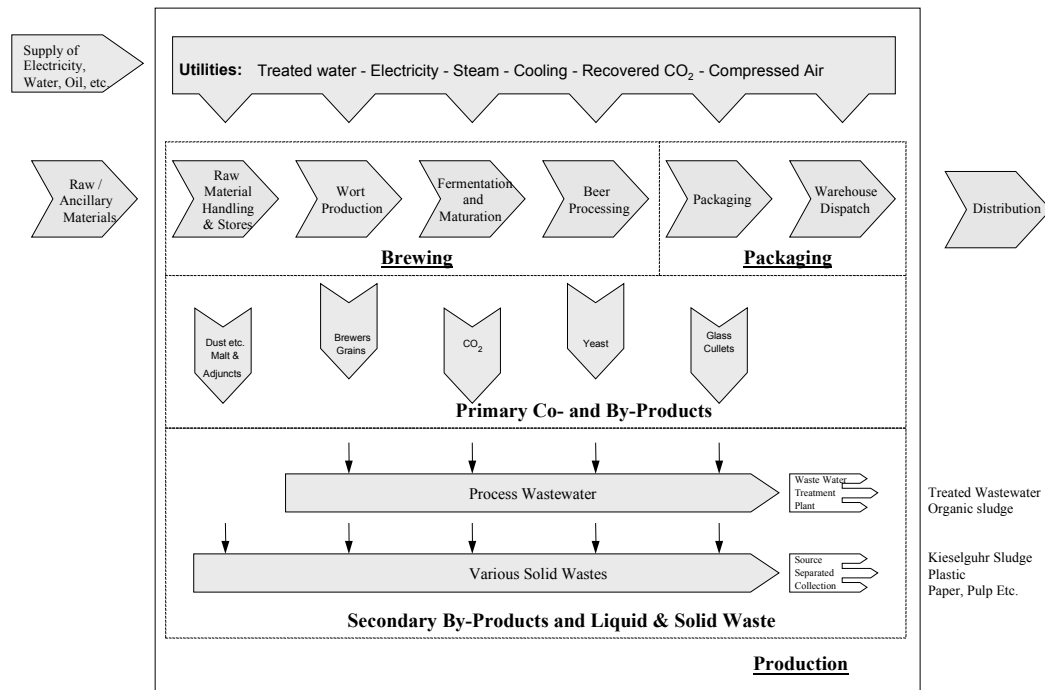

**Figure 1.1: Supply Chain Process**

The following activities can take place at a brewery:

- Malt production. Malt is the most important raw materials for the production of beer. In the past, the brewery generally produced the malt itself. Nowadays, this production step is usually performed by commercial malthouses.
- Production of non-alcoholic beverages / soft drinks in addition to beer.
- Co- and by-products processing. This might or might not take place at the breweries. A short description of possible usage of the co- and by-products will be included.
- Utility production. Most breweries have an utility department with boilers, cooling plant, air compressors, and water treatment plant.

- Wastewater treatment. The existence of a wastewater treatment plant will depend on the local requirement for discharge and costs of wastewater treatment.
- Solid waste processing. The solid waste is normally collected in a solid waste area equipped with compartments or containers for the individual types of waste.

Detailed descriptions of malting, soft drink and by-product processing, utility and wastewater treatment can be found in the BREF for the food, drink and milk industry. These plants will, therefore, be dealt with only to a limited extent in this Guidance Note.

Business processes are included i.e. when relevant to environmental impact from breweries.

## **2. Description of the Brewing Processes**

In this section the following main functions in a brewery are described.

- Production processes
- Beer types
- Utilities
- Business processes

### **2.1 Production Processes**

The raw materials for beer generally include barley malt, adjuncts, hops, water and yeast.

Production methods will differ from brewery to brewery as well as according to beer types, brewery equipment and national legislation. The main processes will, however, be the same:

- Wort production
- Fermentation / Beer processing
- Packaging

#### **2.1.1 Wort Production**

##### **Process Summary**

Malt is delivered to the brewery, weighed, conveyed, cleaned, stored and made available for wort production.

After milling of the malt and preliminary treatment of the adjuncts to facilitate the extraction, the malt and adjuncts are mixed with brewing water to form a mash. Adjuncts are a supplementary carbohydrate supply added either to the mash kettle as starch (e.g. maize grits or rice) or alternatively to the wort kettle as sucrose or glucose / maltose syrup. The mash is heated following a pre-set time - temperature programme, in order to convert and dissolve substances from the malt and the adjuncts in the brewing water.

Extraction is accomplished through a combination of simple dissolution and the influence of the natural enzymes formed during the malting. The substances dissolved in the water are collectively called the “extract”. The solution of extract and water is called the “wort”.

When the mashing is completed the insoluble solids, called the “brewers grains”, are separated from the wort by straining. The brewers grains can be used as cattle feed.

The wort is boiled with hops and hop extracts releasing bitter substances and oils, which are dissolved in the wort. During boiling a precipitate consisting mainly of proteins is obtained (the “trub”) and the bitter substances are isomerised which increases their solubility and. After separation of the trub, the finished wort is cooled to approx. 8-20°C depending on the yeast strain in question and the fermentation process chosen. The cooled wort is hereafter transferred to the fermentation area.

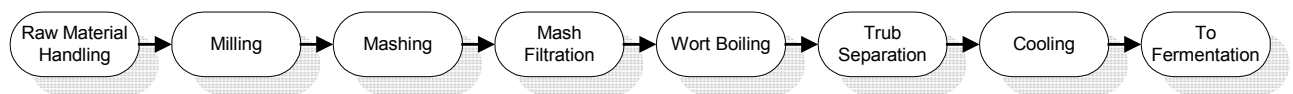

**Figure 2.2: Wort Production**

### **Raw Materials Handling**

The malt receipt department precedes the brewing process and essentially handles the cleaning and storage of the required amount of malt.

The malt reception department is subdivided into several sections. The first section consists of the unloading of the bulk product, its conveyance and cleaning with subsequent storage in silos. In the second section, the malt is conveyed from the storage silos, cleaned, milled and after dry milling stored in process-specific grist cases. The individual steps involved produce malt dust due to abrasion, which must be evacuated and separated in filter systems.

The filter system, equipped with antistatic filter elements, must be designed in such a way as to assure that the dust concentration never reaches the lower explosive limit. Moreover, the filter system must also limit dust emissions in the exhaust air to the levels prescribed by law.

Two different types of conveyance are used for bulk malt deliveries. One is pneumatic conveyance, the other mechanic conveyance. The method used is specific to the application at hand. Mixed forms of conveyance can be found in some breweries.

Depending on the location of the receiving hopper relative to the malt cleaning system or the storage silos, it may be necessary to operate different numbers of conveyor systems. Mechanical horizontal transport is usually implemented by means of closed, dust-tight screw conveyors or chain

conveyors. Mechanical bucket conveyors or pneumatic transport are normally used for vertical applications.

Pneumatic conveyance (compressed air or suction) is used in particular to transport goods long distances with many changes of direction.

For preventive safety of systems and buildings all conveyors, containers and machines are equipped with suitable mechanical and / or electrical safety devices such as for example belt skewing monitors, jam switches, temperature sensors, pressure switches, speed monitors, cellular wheel sluices (pressure surge-resistant, flame propagation-proof), spark detection devices with inerting system, burst protection devices, etc.

Metal and / or gravity separators / screening machines are used to remove foreign bodies. To enhance the cleaning effect, these machines are aspirated and the abraded malt dust is separated in a filter system. Removal of foreign bodies lowers the risk of dust explosions and prolongs the service life of the systems and units. Sparks formed when dry or conditioned malt with foreign bodies is milled may cause dust explosions. For this reason it makes sense upstream from the milling equipment to install a stone remover and a magnet.

### **Milling**

In order to obtain as high as possible a yield of extracted substances as quickly and as efficiently as possible, the malt must first be crushed before being mixed with hot water. Two major types of milling systems are distinguished. These are wet milling, possibly with conditioning, and dry milling which may also comprise conditioning. In the conditioning process the malt is moistened by cold or hot water or by steam. As a result the husks are made more pliable and the husks are left almost intact. When dry milling is applied the whole grain, including the husk, is crushed. The type of dry milling determines how fine grits is produced and to what degree the husk is damaged.

The dry grist is usually placed in intermediate storage in grist cases before it is added to the mash kettle. Contrary to this, the grist from wet milling goes directly into the mash kettle.

Since the extract yield generally increases in direct proportion to the degree of fineness to which the malt is milled, it is preferable for the malt to be crushed to very fine flour. However, this would for lauter tuns cause the filter bed to become clogged during most wort straining operations resulting in an increase in the time required for separation and loss of valuable extract.

In lauter tuns the husks are used as filter bed for separating the brewers grains when straining off the wort meaning care should be taken during crushing to

make sure the husks are not damaged. Conditioning is, therefore, most commonly used in breweries with lauter tuns installed.

On the other hand milling with conditioning cannot be used for mash filters i.e. dry milling is used for breweries with mash filters installed. Hammer mills produce a very fine grist which can be considered for thin bed mash filtration.

The fineness to which the malt is milled is, therefore, a balance between best extract yield, chosen technology and ability to filter the wort.

## **Mashing**

### Malt Mash

The purpose of mashing is to obtain a high yield of extract (of the highest possible quality) from the malt grist and adjuncts by extraction in the brewing water. Some types of proteins and starches are insoluble in water. During mashing, the proteins and starches are broken down by enzymes naturally formed in the grain during malting. Proteases hydrolyse the proteins to peptides and other less complex nitrogenous compounds, and peptidases subsequently break down the peptides to amino acids with optimum temperature at 45 - 50°C. The starch is broken down by the amylase enzyme system to glucose, maltose and dextrans with optimum temperatures for maltose production at 62 - 65°C and saccharification at 70 – 75°C. Factors such as temperature, pH and length of time of mashing must be carefully controlled in order to obtain optimum extraction.

Mashing-in can be performed at any temperature. The optimum temperature of the enzymes that is required to act initially influences the mashing-in temperature.

Depending on the way in which the temperature is raised mashing processes are classified into two types, infusion and decoction mashing. With infusion mashing the entire mash is heated up, with appropriate rests, to the final mashing off temperature. In decoction mashing, the temperature is increased by removing and boiling part of the mash. By returning it back to the remainder the temperature of the total mash is increased to the next higher rest temperature.

The protein in malt is today often highly modified. Therefore, the rest for well-modified malt can be restricted or eliminated by selecting mashing-in temperatures higher than the optimum temperature for protein degradation.

### Adjunct Mash

Adjuncts such as rice or maize are not pre-germinated and do not contribute with supply of enzymes. Furthermore, their starch has a higher gelatinization temperature than malt starch. The adjunct is, therefore, mixed with water and cooked. The adjunct mash is then mixed with the malt mash and the malt enzymes break down the adjunct starch. Sucrose and glucose / maltose syrups can also be used as adjuncts. Since no enzymatic breakdown is required, these adjuncts are added to the wort kettle (see below).

### **Mash Filtration**

During mashing, the substances in the malt and adjuncts are broken down and dissolved in the brewing water. In addition to the soluble material (carbohydrates and protein compounds of various complexity) the mash also contains insoluble material (brewers grains). The wort is separated from the brewers grains by straining. This process is called “lautering”. It takes place in a so-called lauter tun or in a mash filter. Once the so-called first wort has run off, the remaining brewers grains are leached out with sparging water. When a lauter tun is used, the brewers grains also serve as a filter cake to hold back smaller solids particles making sure that the wort run-off is polished. After completion of lautering, the leached brewers grains are discharged to a special brewers grains silo. Brewers grains are traditionally sold to farmers for use as cattle feed. Brewers grains from lauter tuns have a dry matter content of 19 – 22% and from mash filters a dry matter content of 35 – 40%.

The temperature of the wort during lautering is about 75 - 78°C.

### **Wort Boiling**

Following removal of the brewers grains, the wort may be pumped into a pre-run tank which merely serves as a buffer and from there into the wort kettle.

The wort is heated to boiling in the wort kettle and addition of the hops takes place.

During wort boiling:

1. All enzymes are inactivated to prevent the continued breakdown of proteins and starches during fermentation.
2. The wort is sterilised.
3. Bittering of the wort occurs via isomerisation of hop alpha-acids.
4. Unstable colloidal protein coagulates and precipitates.
5. Unwanted flavour components evaporate from the wort.
6. The wort is concentrated.
7. Colour and pH value of the wort is changed.

The wort is normally boiled for 1-1.5 hours with a boiling intensity of 5 - 8 % evaporation per hour of casting volume.

### **Trub Separation and Cooling**

The degree of wort clarity required depends on the type of beer being produced and on brewing practices. The wort should be clear and free of particles (hop residues and proteins, the so-called “hot trub”) before entering the fermenting vessel.

The equipment most commonly used for wort clarification is the whirlpool in which the wort and trub particles are introduced in a tangential direction. Secondary forces on the particles cause them to migrate and accumulate in a cone at the centre of the bottom of the vessel.

After clarification, the wort is cooled to the so-called pitching temperature. “Pitching“ in brewer’s language designates the addition of the yeast. This temperature depends on the type of yeast used and the fermentation process chosen (see below). Cooling normally takes place in a heat exchanger, the so-called wort cooler. The hot water (75 - 85°C) produced is collected and used as brewing water and for cleaning.

### **High Gravity Brewing**

It is possible to produce stronger wort than corresponding to the original gravity of the final beer produced and later, before or after fermentation, to dilute it with water to the desired extract content. Whether dilution is performed before or after fermentation depends among other things on local legislation.

The result will be a considerable increase in the brewhouse and cellar capacity. The main benefit, however, is the large energy saving as the water to be used later in a cold state for dilution does not have to be heated and boiled with the wort.

## **2.1.2 Fermentation / Beer Processing Area**

### **Process Summary**

The cold wort is aerated and “pitched“, i. e. yeast is added. Oxygen (air) is necessary to support development of the yeast to a state and amount capable of fermenting wort efficiently. Fermentation is an anaerobic process; the yeast metabolises the fermentable carbohydrates in the wort forming alcohol and carbon dioxide. A large number of different compounds, such as higher alcohols, esters, aldehydes, etc., influencing the aroma and taste of the beer, are also produced.

When the so-called main fermentation is completed and the yeast has been “harvested“, the green beer “matures“ at lower temperatures. At this stage, the yeast decomposes certain undesirable constituents of the green beer, the beer is enriched with carbon dioxide, the residual extract is fermented and yeast and other precipitates settle.

However, the fine clarity expected by the consumer from most beer types is still missing. This is achieved by filtering the beer. Kieselguhr is used as filtration aid in most cases. During filtering, yeast cells still contained in the beer and other substances causing turbidity and any bacteria that might cause the beer to spoil, are removed. The filtered beer is pumped to the so-called bright beer tanks.

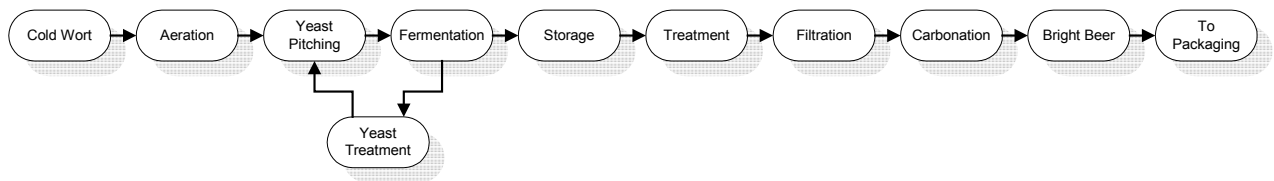

**Figure 2.3: Fermentation / Beer Processing**

### **Fermentation**

Fermentation can be preceded by separation of the cold break – consisting mainly of protein – formed during cooling of the wort. The separation is performed by wort sedimentation in kettles, flotation, centrifugation or filtration.

During the subsequent so-called “pitching“ phase, sterile air or O<sub>2</sub> is blown into the clarified wort and the yeast is added.

Aeration is used to ensure that the yeast is supplied with an adequate amount of oxygen in order to support cell multiplication. Later on, the metabolism of the yeast changes from respiration to alcoholic fermentation; it then processes the carbohydrate molecules contained in the wort to produce ethanol and carbon dioxide. Other ingredients of the wort are also converted. The resulting fermentation products significantly influence the character of the beer produced. The duration and course of the fermentation are determined by the yeast strain and by controlling the process via the parameters pressure and temperature.

Yeast strains are divided into two major groups - top and bottom fermenting yeast. Top fermenting yeast rises to the surface during fermentation, bottom fermenting yeast settles at the bottom at the end of fermentation. Furthermore,

top and bottom fermenting yeast differ with regard to fermentation temperature. Fermentation with bottom fermenting yeast is normally performed between 8 and 15°C. In the case of top fermenting yeast 15 and 25°C is used. Top fermenting yeast produces many esters that can give the beer a typically fruity and floral flavour.

Fermentation takes place in horizontal tanks or cylindro-conical tanks (CCTs). CCTs may be installed indoors or outdoors. The CO<sub>2</sub> produced during the fermentation process can be collected by a CO<sub>2</sub> recovery system.

Heat is generated during fermentation. To maintain the desired fermentation temperature, the fermentation tanks must therefore be cooled. Refrigerants used for indirect cooling are alcohol / water, glycol, ice water or brine. The refrigerant for direct cooling is NH<sub>3</sub>.

Once fermentation has taken place, the yeast is harvested and pumped to the yeast storage tanks. During the fermentation, yeast is produced in excess. A part of this yeast is reused for a new batch of wort, the remainder being disposed of or treated as a co-product. The production yeast may be reused several times (perhaps more than ten generations), but may be replaced due to contamination.

### **Yeast Treatment**

The yeast treatment may involve the following functions:

- Yeast propagation, i.e. production of new yeast
- Pitching of yeast to wort
- Inline cooling at yeast cropping via a heat exchanger (yeast cooler)
- Cleaning at yeast cropping using a yeast sieve
- Cleaning of yeast using acid washing
- Storage of production yeast
- Storage and discharge of surplus yeast. The surplus yeast from fermentation or tank sediment from storage is sold to companies for further processing or is used as animal fodder
- Beer recovery from surplus yeast

### **Storage and Maturation**

The beer is stored for a certain period following fermentation. Storage may take place in the same CCT (one-tank system) or in separate horizontal or cylindro-conical tanks (2-tank or multiple tank system). The green beer is either cooled via the jacket cooling of the tank and / or via an external heat exchanger.

The objective of the storage is to obtain:

- Settling of yeast and other precipitates
- Maturation and development of full flavour
- CO<sub>2</sub> saturation

**Treatment**

After storage the beer is often transferred to cold treatment tanks and rest here for 24 hours or less. During transfer the beer may be centrifuged and cooled via an external heat exchanger to approximately -1°C.

The centrifuge is installed to pre-clarify the beer and thereby reduces the consumption of kieselguhr during filtration.

Cold storage is important in regard to shelf life since a forced precipitation of haze particles takes place enhancing the chemical stability of the beer.

The beer might be chilled prior to filtration (2<sup>nd</sup> cooling).

**Filtration**

The purpose of the filtration is to obtain the specified level of clarity and to facilitate prolonged shelf life.

The filtration takes place in a kieselguhr (diatomaceous earth) filter using frame, candle or mesh filters. Perlites (volcanic residues) are sometimes used instead of kieselguhr. Diatomaceous earth performs the filtration with the filter itself acting as support for the filter cake.

The small diatoms form a rigid but porous filter cake that sieves out particulate matter as it passes through the filter. To prevent "clogging" of the filter and to achieve extended filter runs, kieselguhr is continuously dosed into the unfiltered beer as "body feed", thereby constantly building up the depth of the filter cake.

Spent kieselguhr can be used in farming. Alternatively, it can be used in building materials and it may also be reprocessed. Used filter sheets can be reused, e.g. in the paper industry.

In most cases, filtration is accompanied by stabilisation. Stabilisation is used to selectively remove beer colloids by means of adsorption, e.g. using silica gel and / or PVPP, in order to counteract the beer's tendency to become turbid after filling.

To act as a polishing filter after the kieselguhr filter, a cartridge filter or sheet filter can be installed.

Another possibility in case of PVPP stabilisation is to install an additional regenerative PVPP filter system in combination with the kieselguhr filtration. If sheet filtering is omitted and a PVPP system is in operation, a so-called trap filter must be used.

For polishing and sterilising filtration, several filter systems, e. g. sheet filters, module filters, Cartridge filters and membrane filters, can be used. As an alternative to the sterile filter the beer can be thermally treated (short-time heat processing or tunnel pasteurisation) to increase the microbiological stability. Depending on technical conditions buffer tanks must be used in the unfiltered as well as the filtered areas to safeguard the filtration processes. The filtered beer is pumped into bright beer tanks before filling.

#### **Additional Materials**

Additional materials such as colouring and primings (sugar) can be dosed to the beer.

#### **Carbonation**

In order to achieve the finished product specification for CO<sub>2</sub>, the beer is carbonated before being sent to the bright beer tanks. Nitrogen gas may also be used in small quantities to favour foam performance.

#### **Bright Beer Tanks**

When the filtration process is completed, the beer is stored in bright beer tanks and the beer is ready for packaging.

#### **Cleaning in Place (CIP)**

It is important that all process equipment and pipes are kept clean and disinfected.

Cleaning is done by means of CIP plants where cleaning agents are circulated through the equipment or sprinkled over the internal surface of the tanks. Disinfection takes place in a combination of high temperature, cleaning agents and disinfectants. Caustic and / or acid are normally used as cleaning agents. The cleaning and disinfection of the brewery equipment may use of a substantial amount of energy, water, cleaning agents and disinfectants.

Several CIP units are usually required in order to cover all the process areas in the brewery.

## 2.1.3 Packaging

### 2.1.3.1 Process Summary

From the bright beer tanks the beer is pumped to the packaging area where it is bottled, canned or kegged.

During this final operation it is important that:

- the beer is prevented from getting into contact with oxygen;
- no carbon dioxide is lost as the beer was carbonated to specifications during beer processing

Packaging lines may be equipped quite differently, not only with respect to packaging material but also with respect to the level of automation and inspection.

Returnable bottles require thorough cleaning. The bottle washer consumes large quantities of energy, water and caustic. Furthermore, substantial quantities of wastewater are discharged. The use of non-returnable packaging material reduces the consumption of energy, water and caustic, therefore reducing wastewater generation.

In packaging lines using non-returnable bottles and cans, the bottles / cans are only flushed with water before filling. Alternatively, compressed air is used to blow out any dust particles.

If kegs are used, they are cleaned and sterilised with steam before filling.

Below the most important functions of the packaging lines for returnable / non-returnable bottles, cans and kegs are shown and described.

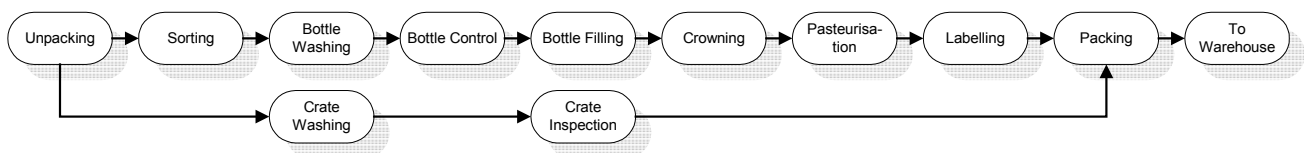

### 2.1.3.2 Returnable Bottles

**Figure 2.4: Packaging Returnable Bottles**

**Un-packing**

The bottles are lifted from the crates by gripper heads and placed on a large conveyor from where they are transported to the sorting machine.

Empty crates are transported to the crate washer.

**Sorting**

The returned bottles are sorted electronically. Foreign bottles are returned to their respective manufacturers or crushed and sent to recycling.

**Bottle Washing**

Before being filled with beer, the returned bottles are converted to a bottle washer that cleans the bottles both inside and outside. Inside the bottle impurities include residual beer mould, cigarette butts, organic solvents, etc. Outside impurities may include labels, aluminium foil and dust particles.

Bottle washing is likely to consist of soaking, rinsing, sterilisation and re-rinsing. To improve the cleaning effect surfactants, complexation agents and similar agents are added to the cleaning solution. In order to guarantee the hygienic condition of the bottles, disinfectants may be added in the rinsing zones of the bottle-cleaning machine.

**Bottle Control**

When a bottle has been cleaned, it is inspected for damage or residual dirt. The systems used to detect such undesirable bottles are named EBI (Empty Bottle Inspection). Bottles that are dirty but sound are returned to the bottle washer while broken bottles are collected and recycled.

**Bottle Filling**

The bottles are transported on conveyor belts from the bottle washer to the filling machine. They are filled (on circular continuous systems with short- or long-tube fillers having mechanically, pneumatically or electronically controlled valves) under pressure according to the quantity of dissolved carbon dioxide in the beer.

In addition to filling bottles, the most important function of the filling machine (which may have various forms) is to prevent oxygen coming into contact with the beer.

The bottles are evacuated and counterpressurised with CO<sub>2</sub> before the actual filling of beer.

### **Crowning**

The bottles are closed up immediately after filling (usually with crown corks) and the filling volume is checked. Furthermore, the presence of crown cork is checked. The sealed bottles can then be conveyed to the tunnel pasteuriser. Bottles that are sorted out are emptied and returned to the bottle washer.

### **Pasteurisation**

If the beer has not been sterile filtered, the beer might be pasteurised to prolong shelf life. It is important that all micro-organisms capable of growing in the beer are destroyed. Pasteurisation guarantees practically unlimited biological stability.

Two different methods are used for the pasteurisation:

- a) tunnel pasteurisation, during which the beer is pasteurised in bottles (or cans), i.e. beer and bottle is pasteurised as a closed unit
- b) flash pasteurisation, employing a heat exchanger in which the beer is pasteurised before it is filled into bottles (or kegs).

### **Labelling**

Following tunnel pasteurisation, the bottles are conveyed to the labeller. The design possibilities are virtually unlimited with labels on the body, back and neck, bands, bows, foils, etc. Glues (e.g. starch- or protein-based) are used as adhesives so that the labels come off easily when the returnable bottles are cleaned. To guarantee optimal removal of the old labels in the bottle washing machine, special, high wet strength label paper can be used.

### **Packing**

The bottles are packed in crates, cartons or other forms of transport packaging and palletised.

### **Crate Washing / Inspection**

The crates are washed with water and inspected for damages, colour, logo, etc. Sound and correct crates are sent to the packaging machine.

### 2.1.3.3 Non-returnable Bottles

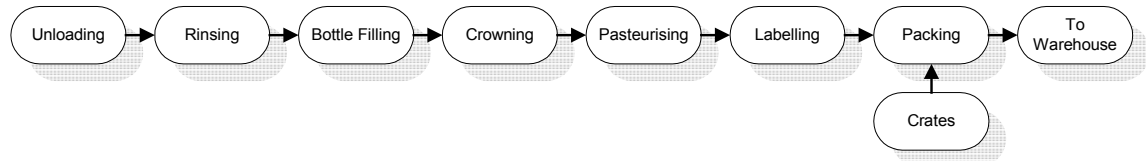

**Figure 2.5: Packaging Non-returnable Bottles**

For packaging lines using non-returnable bottles the phases are the same as described for the returnable bottles - from filling of the bottles and onwards. However, the first steps are different for non-returnable bottles as the bottles are not delivered in crates, washed and sorted. Instead the following two activities which are similar to the ones for cans take place:

#### **Unloading**

Non-returnable bottles are delivered on pallets from the glassworks. The bottles are pushed off the pallets in layers onto a reception table / conveyor chain. When a layer has been pushed off, the spacer packaging is removed and returned to the manufacturer.

#### **Rinsing**

The bottles arrive clean from the glassworks but dust can get into the bottles during transport. Therefore, the bottles are rinsed before filling either by spraying with water or the dust is blown out with compressed air. For rinsing the bottles are turned so that their openings face downwards and they are then turned upright again before filling.

### 2.1.3.4 Cans



**Figure 2.6: Packaging Cans**

#### **Unloading**

Cans are supplied in bulk as so-called tall packs. The cans are pushed off the pallet in layers onto a conveyor chain. When a layer has been pushed off, the spacer packaging is removed and returned to the manufacturer.

### Marking

The latest sales date is usually marked on the bottom of the cans. Since the cans are wet all over, later marking with the shelf life date and other information is performed while the cans are still dry.

### Rinsing

The cans arrive clean from the manufacturer, but dust can get into the cans during transport. Therefore, the cans are rinsed before filling either by spraying with water or the dust is blown out with compressed air. For rinsing the cans are turned so that their openings face downwards and they are then turned the right way up again before filling.

### Can filling

Filling of cans is based on the same principles as short-tube bottle filling. Because of their low weight it is necessary to convey the cans gently to ensure a constant spacing. The cans are separated on special pocket chains and placed on the can conveyor. Furthermore, special attention shall be paid to the thin wall thickness and thereby low stability of the cans.

### Sealing

The cans are sealed with lids immediately after filling and as for the bottles the filling height is checked. Sealing of cans is a two step operation (pressing first with a pre-roller and secondly with a seaming roller) that shall be performed exactly right to prevent pressure loss and thus beer spoilage.

### Pasteurisation

The cans may then be pasteurised. The same principles apply to can pasteurisation as to bottle pasteurisation but as the cans transfer heat better than glass the process proceeds more quickly.

#### 2.1.3.5 Kegs



Figure 2.7: Packaging Kegs

**Depalletising / Palletising**

Kegs are transported on pallets. The depalletising / palletising is usually performed layer by layer by pushing the kegs together and displacing or lifting the layer by pneumatically operated grippers.

**Decapping**

The caps that protect the spear (fitting for cleaning, filling, emptying and closing of the kegs) from dirt during transport and storage must be removed before the kegs are cleaned and refilled.

**Inversion**

Before filling the empty kegs must be arranged with the fittings at the bottom. The inverting device, therefore, rotates kegs that are not upside down 180°.

**Pressure Testing**

Kegs are always under pressure. If the pressure is below a certain limit, the spear is not sealed. In this case the keg is ejected for repair.

**External Cleaning**

Pre-soaking, cleaning and rinsing clean the outside of the keg. The cleaning solution is recirculated.

**Internal Cleaning and Filling**

Internal cleaning and filling of kegs is performed in many stages in one or more filling streets. First the kegs are cleaned with water and caustic and sterilised with steam. Afterwards the kegs are pressurised and filled with beer. Before discharge the head is rinsed. Weighing of the kegs controls the filling volume.

**Capping**

Protective plastic caps are put on the fittings.

**2.1.3.6 Warehouse**

Packed beer is stored in the warehouse. It is important to store bottled beer inside as sunlight destroys the beer quality.

Warehouse for glass bottles situated in a cold climate should be heated in order to prevent bottle breakage.

## 2.2 Beer Types

Different beer types are produced which differ from one another in taste, colour, aroma, mouth feel, foam, etc. Parameters influencing the wide spectrum of beer types are choice of brewing materials, yeast strain and production methods.

In order to produce different types of beers, portions of various malts and adjuncts must be used. Pilsner malt is the most commonly used malt type. Other malts in question may be dark malt (Munich malt), crystal malt, black malt, wheat malt, etc. Malt may be supplemented by adjuncts. Adjuncts may be maize, rice, barley, wheat, sugar, etc. depending on region.

The choice of yeast strain has a large influence on the flavour of the beer. Yeast strains are divided into two major groups – top and bottom fermenting yeast. Top fermenting yeast strains typically produce beer with a more fruity and floral flavour than bottom fermenting yeast strains. In rare cases bacteria, e.g. lactic acid bacteria, may be used to ferment the beer.

Most beer types can be produced using the methods described earlier. However, for some products the production method may vary on one or more points. Examples are: Addition of fresh wort before secondary fermentation; Ice beer production; Nitrogen may be used when dispensing draught beer (or in cans with wickets) giving a very persistent foam; Alcohol-free beer may be produced by suppression of alcoholic fermentation or removal of alcohol.

## 2.3 Utilities

To run a brewery, as in other industries, utility installations are necessary. These comprise:

- Boiler plant
- Cooling plant
- Water treatment plant
- CO<sub>2</sub> recovery plant
- Nitrogen generation
- Compressed air plant
- Electricity supply

### **Boiler Plant**

The processes are supplied with heat from a boiler plant. The heat is available to the various consumers as steam or high temperature hot water.

Oil, natural gas, biogas or coal may be used as fuel for the boilers.

**Cooling Plant**

Process cooling is supplied from a cooling plant using reciprocating, screw or centrifugal compressors. The cooling at the consumers may take place directly by expansion of a primary refrigerant – mostly ammonia – or indirectly by use a secondary coolant such as propylene glycol.

**Water Treatment Plant**

Water can be supplied from wells or surface intake. If the water is supplied from own intakes, it must be treated in conventional water treatment plants. The water quality typically meets requirements for drinking water.

Different water consumers in the brewery require special water qualities, typically with low content of hardness or chlorine. For removal of hardness, softening plants are installed which are regenerated using either salt or acids. For the removal of disinfection, residual activated carbon filters are normally used.

Water consumption in breweries varies significantly in flow. Many breweries have, therefore, installed water reservoirs and use booster stations for local water supply.

For the high gravity brewing a special water quality must be produced, which must have a very low oxygen content.

**CO<sub>2</sub> Recovery Plant**

The CO<sub>2</sub> generated during the fermentation process can be collected and cleaned and then reused for the process. CO<sub>2</sub> is necessary for carbonating and for counter pressure in tanks and bottles.

If no CO<sub>2</sub> recovery plant is installed, the brewery has to buy CO<sub>2</sub> from outside.

**Nitrogen Generation**

Some breweries use nitrogen instead of CO<sub>2</sub> for counter pressure in tanks and bottles.

Nitrogen can be generated on site by use of atmospheric air through either a thermal or membrane separation technique.

Nitrogen can also be supplied in bulk from external services.

### **Compressed Air Plant**

Compressed air is mainly used for instruments, pressurising of tanks, actuators and possibly brewers grains transport.

The compressed air is supplied from a compressed air plant.

Different systems may be used depending upon the pressure and air quality requirements of the consumers.

### **Electricity Supply**

Most breweries are supplied with electricity from the public grid. A few will have their own co-generation plant producing both electricity and heat / steam.

If the electricity supply is not stable, emergency generators may be required.

## **2.4 Business Processes**

### **Sourcing**

The purchasing function is important when controlling the environmental impact from breweries.

Purchasing normally includes:

- Selection of supplier
- Choice of quality
- Arrangements for delivery including packaging size and material
- Return of packaging material

Examples of environmental topics related to sourcing is the purchase of fuels with a minimum sulphur content and malt with a minimum content of dust, stones and broken grains.

### **Quality and Environmental Assurance / Control**

A laboratory is necessary to perform quality and environmental control. Brewery laboratories vary considerably from brewery to brewery. Well-equipped laboratories provide quality control checks on all aspects of raw material control and use, brewing, fermentation, storage filtration and packaging. In addition, they can analyse consumer product samples, process water, cleaning water, effectiveness of cleaning procedures, wastewater, etc. on a routine basis.

Product quality is closely connected to the environment. Breweries will not compromise on product quality meaning that a good product quality will reduce the breweries' impact on the environment. In addition, the quality control will supply data on which the environmental management can be based.

### **Production Planning**

Planning is an important tool in controlling the environmental impact from breweries. Proper production planning will increase the productivity resulting in less resources needed, e.g. reduction in product changes on the packaging lines will result in less chashing water being used.

### **Information Technologies**

Breweries have always highlighted parameters such as extract utilisation, loss, etc. Higher extract utilisation and less loss will reduce the breweries' impact on the environment. In order to be able to supply these data fast and efficiently to the decision makers information technology will be the tool in the future for the integration of production quality and environmental information in management systems.

### **Human Resources**

Training is important in order to improve the employees' awareness in relation to quality and environmental issues.

Training and awareness programmes for new and old employees and temporaries are an integrated element for many breweries and represent an opportunity to include environmental training.

### 3. Environmental Impact

#### 3.1 Type of Environmental Impact

The major public concern of breweries has traditionally been about wastewater pollution from untreated discharges. Locally, the odour and the noise from the operation have caused public concern.

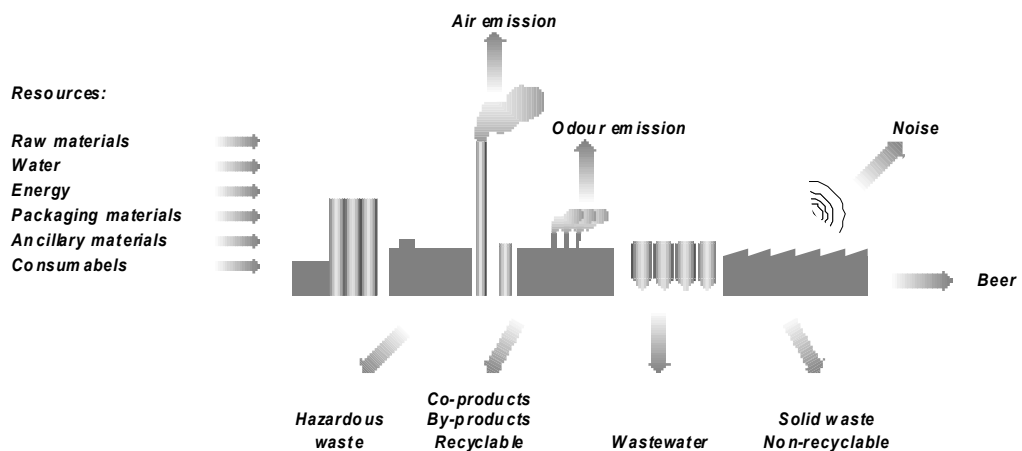

**Figure 3.1: Environmental impact from a brewery**

The environmental impact from breweries is shown in the figure above and can be divided into 3 groups: resource availability, nuisances and toxic effects.

The resource utilisation is an issue which should be seen from a sustainable development perspective, scarcity of water resources, combustion of fossil fuels, utilisation of raw materials, emission of ozone depletion chemicals, CO<sub>2</sub>, etc.

Compared to other types of industries the utilisation of resources is the most characteristic environmental impact from breweries. This means that optimisation of the resource utilisation will result in reduced environmental impact and operational costs.

The nuisance impact is typically felt by the neighbours of a brewery and is related to the emission of noise, odour (even in cases of high acceptance rates) and dust mainly from handling malt and adjuncts.

Reduction of the nuisance impact will often result in additional costs and is to some extent coupled with occupational health measures.

The toxic effect is more diverse as it covers the toxic impact from uncontrolled products or chemical spills into e. g. rivers and wastewater treatment plants.

Potential toxic impact from breweries is often related to the evaluation of purchased goods and the contingency measures employed in order to reduce the effects of accidents.

## **3.2 Geographical Impact**

The environmental impact by beer production is dealt with seen separately from a global, regional and a local perspective.

### **3.2.1 Global**

From a global perspective, the environmental impact is primarily related to the breweries' consumption of energy generated from fossil fuels such as natural gas, oil and coal. In this relation it is emphasised that not only the actual energy consumption (in MJ) is considered, but also the environmental effects of compounds in the fuel and the combustion residuals such as the emission of CO<sub>2</sub>, SO<sub>2</sub> and NO<sub>x</sub> in the flue gasses.

It should, however, be noted that the CO<sub>2</sub> emission from the fermentation process is not relevant as it concerns short cycle CO<sub>2</sub>. In this cycle CO<sub>2</sub> is taken up from the atmosphere by the barley plants and during the fermentation process released again.

### **3.2.2 Regional**

From a regional perspective, 3 subjects of concern are identified, i.e. water, wastewater and solid waste.

The actual water consumption of a brewery may have an impact on the exploitation of the available water sources. Overexploitation of water resources can have effects such as deterioration of the water recipients and the quality of the water itself.

In addition previous and existing handling of fuel oil, other oil products, chemicals and lubricants may constitute a risk for pollution of surface and ground water.

Untreated brewery wastewater discharged in surface waters can bring about a rapid deterioration of their physical, chemical and biological qualities. Their decomposition depletes the dissolved oxygen in the water that is vital for aquatic life. Release of nitrogenous and phosphorous compounds in the wastewater will stimulate aquatic plant growth contributing to eutrophication of water bodies. Further, due to turbidity and colour photosynthesis may be restricted and thereby affecting the primary link in the food chain.

However, within the EU, the discharge of untreated wastewater will cease by the implementation of EU Directive 98/15/EEC on urban wastewater treatment. This means that brewery wastewater has to be treated either by a brewery owned plant or by third parties, e.g. public wastewater treatment plants. The environmental impact of wastewater discharge is then reduced to the effects from the energy consumption, solid waste generation and the treatment efficiency of the wastewater treatment plant.

Generation of solid waste that cannot be reused or recycled requires disposal at a landfill even after possible utilisation of the energy in an incinerator. Available landfill area is a very limited resource within Europe.

For the hazardous waste which is regulated according to EU directive 2000/532/EC, special handling and disposal schemes must be followed. However, the hazardous waste generation in breweries is in general limited to spent laboratory chemicals.

### **3.2.3 Local**

From the local perspective 3 subjects of nuisance are identified: i.e. noise, odour and dust. In addition, the local surrounding may suffer an environmental impact due to risk activities.

Excessive noise may cause problems in the surrounding society, especially noise during the night. Noise from breweries comes from transport to and from the brewery, internal transport and noise from stationary sources such as cooling towers, conveyers and ventilation.

For a brewery the odour is not noxious. The odour mainly comes from the wort boiling and has a bread-like smell. Fermentation, bottle washers, by-product storage tanks, silos and wastewater treatment plants are other possible odour sources.

Dust emission generated mainly through raw material conveying and kieselguhr handling can cause local problems.

The risk activities in a brewery are associated with dust explosions from conveying and handling the raw materials, fire especially in connection with

storage of fuel oils and the release of NH<sub>3</sub> from the cooling plant. Accidents caused by either of these activities may cause damage to the local environment. The activities are, however, regulated under local safety statutory orders.

#### **3.2.4 General**

As a subject with relevance to the environmental impact for all three geographical areas is the utilisation of raw materials identified.

The reason for this is the effect which poor utilisation of raw materials has on the environmental impacts. Loss of beer at a late stage in the production will, therefore, also imply unnecessary energy and water consumption, wastewater discharge, solid waste generation, and nuisance for the local surroundings.

## **4. Resource Consumption and Emissions**

When addressing the subject of resource consumption and emission it is important to focus on the area within the production that will have the largest effect. The objective of the following chapter is to identify the most significant resource consumers and emission generators within the brewery.

The content of this chapter will follow the structure of chapter 3.

### **4.1 Global**

#### **4.1.1 Energy Production and Consumption**

Energy is supplied to breweries in the form of oil, gas, coal, steam, high temperature hot water and electricity.

Energy will be discharged from the brewery to the air (as hot flue gas, low temperature radiation and steam) as warm wastewater and to a small extent as warm brewers grains.

The most important environmental subjects for a brewery to consider will, therefore, be:

- Production synergies
- Selection of energy source(s)
- Combustion efficiency and possible flue gas treatment
- Energy efficiency within the production
  - Reduction of the steam and vapour release
  - Insulation of hot surfaces
  - Electric motors with high efficiency
  - Process integration. Utilisation of the energy potential from high temperature waste energy as to generate energy at a lower temperature to be used by consumers, which do not require the high quality
  - Heat recovery
  - Reduction of condensate and hot water discharge
  - Optimising cooling plant evaporation and condensing temperatures

#### **4.1.2 Production synergies**

A brewery utilises energy both in the form of heat and electricity. As production of electricity at conventional power plants produce waste heat many countries promote different scheme for combined heat and power

production at heat consuming industries in order to ensure an overall reduced environmental impact.

Breweries in some countries have already invested in these CHP plants, however the incentives for construction and operation of a CHP plant are deeply depending upon the economical incentives and legal concession for power production and distribution.

#### **4.1.2.1 Selection of Energy Sources**

The environmental impact from different types of energy sources varies significantly both with regard to CO<sub>2</sub> and SO<sub>2</sub> emission. However, constraints concerning e.g. natural gas distribution, legal concessions for power production and distribution, external heat and electricity supply limit the possibilities to change the environmental impact.

Legal requirements have been set for the content of commercially available fuels - e.g. to the sulphur content.

However, within the legal frames it is possible for a brewery to choose between different qualities of oil and coal.

In addition possibilities exist to substitute fossil fuels with non-fossil fuels, e.g. biogas from anaerobic wastewater treatment plants.

#### **4.1.2.2 Combustion Efficiency and Flue Gas Treatment**

Heat is normally distributed in the brewery as steam or high temperature hot water (HTHW). The production of heat should utilise the energy in the fuels as efficiently as possible.

Legal requirements to boilers typically state standard flue gas concentrations. The boilers shall meet these requirements. In addition possibilities exist for adjustment and modification of the burners, e.g. by replacement with low NO<sub>x</sub> burners.

For detailed information concerning the environmental impact in connection with heat production and flue gas treatment reference is made to the BREF.

#### **4.1.2.3 Energy Efficiency within the Production**

##### **Heat**

The heat consumption at a brewery is today 100 - 200 MJ/hl. This is the consumption figure for a brewery without a sophisticated heat recovery system,

but which uses well-known heat recovery and conservation techniques (proper insulation, steam condensate recovery, good maintenance level, etc.).

The actual heat consumption for a brewery depends on process and production characteristics such as packaging method, pasteurising technique, type of equipment, and by-product treatment.

For breweries with a low maintenance level, without well-known energy conservation techniques and low energy prices, the consumption of heat can be 2 times the above figure.

The main heat consuming processes in a brewery are:

- Mashing
- Wort boiling
- Generation of hot liquor
- CIP / Sterilising
- Bottle washing
- Keg washing
- Pasteurising
- Room heating (in cold climate)

The largest single heat consumer will normally be the wort kettle.

The main reasons for high heat consumptions in a brewery are:

- High evaporation rate in the wort kettle
- Poor utilisation of hot water produced during wort cooling
- Poor control of the processes
- Low efficiency of equipment and plants
- Leaking pipe systems
- Lack of insulation
- No (or badly designed) steam condensate return system
- Low boiler efficiency
- No heat recovery
- No (or inefficient) resource management system

### **Electricity**

The electricity consumption is about 8 - 12 kWh/hl depending on process and production characteristics.

Some breweries will have an electricity consumption 1.5 - 2 times the above figure due to ineffective production, no energy consciousness, etc.

The main single consumers of electricity in a brewery are:

- Packaging area
- Cooling plant
- Compressed air plant
- CO<sub>2</sub> recovery plant
- Wastewater treatment plant
- Air conditioning

There are also many small consumers of electricity counting for a large part of the electricity consumption, e.g. pumps, ventilators, drives and electric lighting.

The main reasons for a high electricity consumption are:

- Low efficiency of equipment
- Equipment does not stop during idle or low production times
- Low efficiency of plants
- Leaking compressed air system
- Too high condensing temperature or too low evaporating temperature in the cooling plant
- Poor of control of the processes
- No (or insufficient) resource management

## **4.2 Regional**

### **4.2.1 Water**

Water may be supplied to the brewery from public suppliers either as ground water, surface water or treated drinking water.

Water will leave the brewery as beer, as a part of by-products (brewers grains and excess yeast), wastewater or as steam and vapours.

The water consumption is about 4 - 10 hl/hl beer. This figure varies depending on how the beer is packaged and pasteurised, the age of the plant and the type of equipment. Furthermore, the raw water temperature will affect the water consumption as water is often used as cooling medium. In areas with cold water, the water consumption is normally lower than in areas with high temperatures.

The largest water consuming processes are:

- Mashing and sparging
- Cleaning of packaging material (e.g. bottle washing)
- Pasteurisation (tunnel)
- Rinsing and cleaning of process equipment (CIP)
- Cleaning of floors
- Soap lubrication of conveyors in the packaging area
- Vacuum pump for filler
- Flushing of filler
- Keg washing

The main reasons for a high water consumption are:

- High consumption of water for bottle washer
- Overflow in the hot water system
- Pasteurisers out of balance
- Cleaning of process equipment
- Water used for cooling of tunnel pasteuriser in an open system
- High water consumption for vacuum pump in packaging area
- Low efficiency of equipment and plants
- Closed loop cooling system is not working satisfactorily
- Leaking valves, running taps and hoses
- No (or insufficient) resource management system

#### **4.2.2 Wastewater**

##### **Volume**

The wastewater discharge will be equal to the water supply subtracted the produced beer, evaporated water in brewhouse and utility plants, and the water present in the by-products and solid waste. About 1.3 – 1.8 hl water per hl beer does not enter the sewer system.

##### **Organic material**

Organic material mainly enters the brewery in the form of raw materials such as malt and adjuncts. In addition organic material may enter the brewery as “other input sources” consisting of cleaning additives, lubricants for conveyors and residual products in the bottles.

Organic materials will mainly leave the brewery as beer, by-products and wastewater. In order to reduce the organic content of the wastewater focus must be put on the loss of intermediate products and beer and on collection of by-products.

The traditional characterisation of brewery wastewater is the content of organic material, which is often measured as either COD or BOD.

The potential largest COD discharging processes are:

- Brewers grains
- Yeast and surplus yeast
- Trub
- Weak wort discharge.
- Emptying of and rinsing water from kettles.
- Emptying of process tanks.
- Pre- and after-runs from kieselguhr filtration and filling
- Chase water from process pipes.
- Rejected beer in the packaging area.
- Returned beer.
- Breakage of bottles in the packaging area.
- Ancillary materials used in packaging area e.g. adhesive for bottle washer, conveyor lubrication and label glue.

The main causes for large COD discharges are:

- Discharge of by products to the sewer system
- Product loss

### **Other substances**

Suspended solids in the wastewater originate from the discharge of by-products, kieselguhr and possible label pulp from the bottle washer.

Nitrogen in the wastewater originates from discharge of yeast and cleaning agents e.g. nitric acid that can be a part of the detergents used for tank cleaning. In connection with the maintenance of the cooling plant  $\text{NH}_3$  discharge may occur.

Phosphor in the wastewater originates mainly from the detergents used for tank cleaning.

The usage of acids and caustic for the cleaning of process equipment and returnable bottles results in large variation of the pH in the wastewater. A potential risk exists in connection with the storage and handling of concentrated acids and caustic to cause major discharge of acid and caustic, which may upset the operation of the wastewater treatment plant.

The main sources for discharge of acid and caustics are:

- Water treatment plant
- CIP plant
- Brewhouse
- Acid and caustic storage tanks including loading stations and internal distribution.
- Bottle washer.

The main reasons for large discharges are:

- Accidents
- Short drain periods of CIP tanks containing acid or caustic
- Emptying of caustic baths in bottle washer.

### **4.2.3 Solid Waste**

Solid materials enter the brewery in the form of raw and ancillary materials. The solid material leaves the brewery as co-products (brewers grains and surplus yeast), primary and secondary packaging material, solid waste and hazardous waste.

The hazardous waste is regulated by EU Directive 2000/532/EC and has to be handled according to the legal requirements. In general a very small amount of hazardous waste is produced, e.g. spent laboratory chemicals and batteries.

Major co-, by-product and solid waste fractions are identified by the following example:

The generation of co-, by-products and solid waste is quantified for a 1 mill. hl/year brewery producing mainly returnable bottles in plastic crates and without generation of flue gas and wastewater treatment residuals.

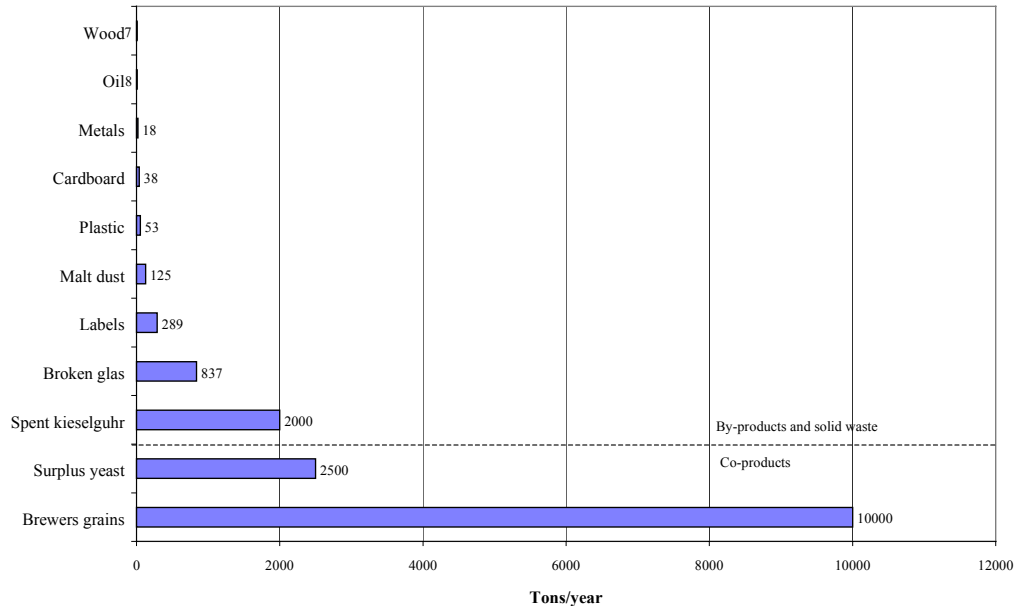

**Fig. 4.1 Example of co-, by-product and solid waste quantities from a brewery**

Residual streams from breweries may be divided into:

- Co-products linked to the production process
- By-products and recyclable
- Non-recyclable (solid waste)

The co and by-products are in general useful and many different applications have been reported:

- Malt dust. Animal fodder, mixing into brewers grains, utilisation in the production.
- Brewers grains. Animal fodder, including trub from the whirlpool.
- Surplus yeast. Animal fodder, yeast pills, cosmetics, pharmaceutical industry, spreads.

As shown in the figure it is important to ensure a reliable use of the major co- and by-products, brewers grains and surplus yeast.

Recyclable waste examples from breweries are:

- Spent kieselguhr from the beer filtration that could be used in the cement industry.

- Broken glass from the packaging lines that can be re-used for glass manufacturing.
- Label pulp from the washing of returnable bottles that can be re-used in paper manufacturing.
- Plastic from supply of ancillary materials, wrapping of products, etc. that can be recycled.
- Cardboard and paper from the supply of ancillary materials that can be re-used by paper factories pending upon the pulp quality.
- Metal from hop cans, replacement of equipment, etc. that can be melted and used in the metal industry.

Through source separation the brewery strives to increase the ratio of recyclable waste.

The main reasons for large solid waste generations shall therefore be found in the organisation of the co-product handling, by-product disposal and the options for disposal of recyclable materials.

## **4.3 Local**

### **4.3.1 Noise**

The noise emission from a brewery can be divided into transport noise and noise from stationary sources.

Transport noise mainly comes from the distribution trucks and forklifts. From stationary equipment it is mainly noise from condensers and cooling towers that can be heard outside the brewery.

The main noise sources are:

- Transport within the brewery both with lorries and forklifts.
- Condensers and cooling towers for the utility plants.
- Raw material transport within the brewery.
- Ventilation fans.

The main reasons for large noise nuisances are:

- Location toward neighbouring area.
- Poor maintenance of outdoor equipment.
- Activities during night time.

The environmental impact of noise emitted by the brewery should be assessed by a study of the specific emission sources.

It shall be noted that noise within the brewery is also an OH&S concern in the utility areas (compressors) and in packaging areas (glass bottles). The noise level may occasionally exceed 85 dBA, especially when using old equipment.

#### **4.3.2 Odour**

The largest source for odour emission from a brewery is the evaporation from the wort boiling.

The main potential odour sources are:

- Vapours from wort boiling.
- Wastewater treatment.
- Storage and handling of co- and by-products.
- Oil storage.
- Ventilation of beer cellars and packaging lines.
- Stack emission from the boiler house.

The main reasons for odour nuisances are:

- Location toward neighbouring areas.
- No vapour condensing from wort boiling.
- Mal-operation of heat recovery system for the wort boiling.
- Storage of by-product during summer periods.
- Content of sulphate in wastewater, which will cause malodours if the wastewater becomes anaerobic.

#### **4.3.3 Dust**

The raw material intake and transport mainly generate dust. In addition, dust could be generated by the supply and handling of filtration aids such as kieselguhr.

However, as the dust emission from these systems normally is limited by the integration of cyclones and bag filters, the emission is very restricted.

The main reasons for dust emissions are:

- Raw material unloading.
- Maintenance of cyclones and bag filters.

#### **4.3.4 Risk Activities**

Impact on the local environment can occur in the event of the following accidents and incidents at the brewery:

- Explosion of malt dust
- Fire from storage of fuel oils
- Release of ammonia from the cooling plant
- Accidents in chemical handling

The risks of these activities are all covered by safety regulations that must be complied with.

### **4.4 General**

#### **4.4.1 Utilisation of Raw Materials**

Insufficient utilisation of the raw materials related to the recipe will lead to more raw materials and intermediate products need to be processed in order to give the same output as if the raw materials were utilised 100%. This will result in an overall larger consumption of resources, i.e. energy, water, generation of wastewater, solid waste and nuisance.

The main reasons for poor utilisation of the raw materials are:

- Poor raw material quality
- Insufficient crushing of the malt
- Inappropriate mashing procedure
- Poor lautering, incl. insufficient sparging
- No collection of weak wort
- Poor clarification resulting in a high trub volume
- No recovery of wort from trub
- No recovery of beer from surplus yeast
- No collection of residual beer, including pre- and after-run beer

### **4.5 Typical Resource Consumption**

The following table indicates a range for resource consumption figures, which is considered as being acceptable for European breweries applicable for IPPC environmental permits.

<b>Parameter</b>	<b>Unit</b>	<b>Range</b>
Heat consumption	MJ/hl *	100 – 200
Electricity consumption	kWh/hl	8 – 12
Water consumption	hl/hl	4 – 10
Wastewater discharge	hl/hl	2.2 – 8.7
Wastewater discharge	kg COD/hl	0.8 – 2.5
Solid waste	kg/hl	<1 – 20 **
Malt	kg/hl	10 – 20 ***

\* Hl of finished product.

\*\* The high end of the range for breweries unable to dispose of their co-products e.g. during summer periods.

\*\*\* The malt consumption is e.g. depending upon the strength of the beers produced.

## 5. Best Available Techniques

The term “Best Available Techniques” (BAT) is defined in the IPPC directive Article 2 (11). By the words “Available” and “Techniques” is meant available under both economically and technically viable conditions and that not only technology is to be considered but also the operation.

In order to use “Best Available Techniques” a search has to take place in order to evaluate potential BAT candidates. BAT’s are changing over time, so different sources have to be consulted e.g. supplier offers or own developments have to be considered. As soon as a BAT candidate is identified it has to be assessed on its applicability. The scheme in Fig. 5.1 depicts the factors which influence its acceptability.

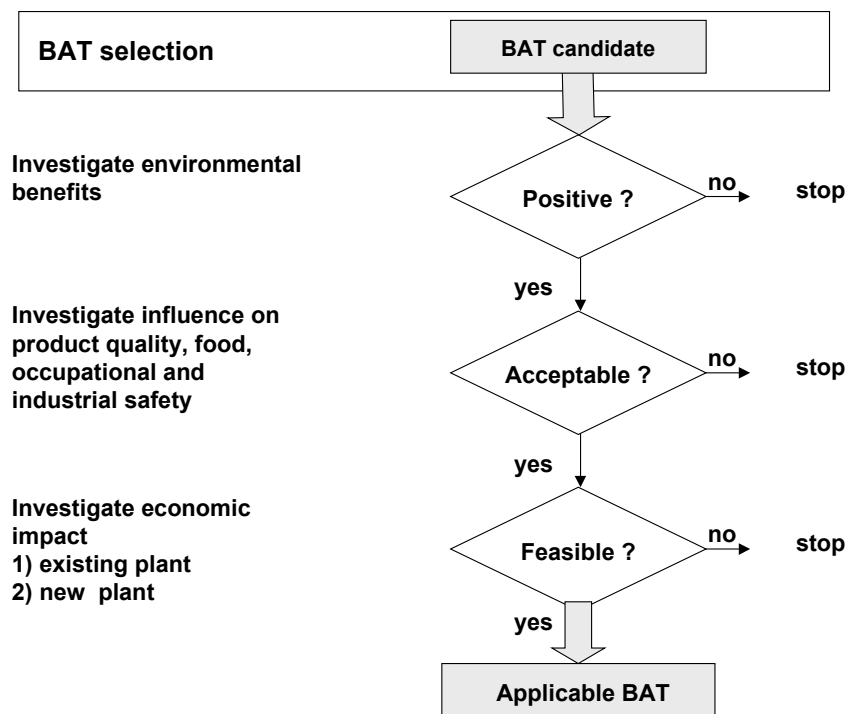

**Figure 5.1: BAT Applicability Scheme, from Dutch Brewers Association**

The first assessment is whether the BAT candidate fulfils the environmental objectives. If positive on environmental benefits, the BAT candidate has to be screened on the effects on product quality, food, occupational and industrial safety.

Last but not least the economic impact has to be assessed which depends on existing or new plants and the size of the brewery.

For the environmental subjects identified in chapter 3 and 4 the following chapter contains a selection of priorities, and a discussion of BAT's that will have a major effect on the environmental impact on and a table of other potential BAT's, which might have an environmental impact.

## 5.1 Energy

### 5.1.1 Selection of Priorities

The following subjects have been identified as being of priority in order to minimise the environmental impact of the energy supply:

- Evaluation of production synergies
- Use of commercial available low-sulphur fuel
- Use of low NOx burners and regular maintenance of the boiler
- Regular inspection of the integrity of the cooling systems
- Energy management including benchmarking of the specific energy consumption
- Assessment of potential BAT's

#### **CASE STUDY: REDUCTION IN SULPHUR EMISSION BY CHANGING FROM HEAVY FUEL OIL (HFO) TO LIGHT FUEL OIL (LFO)**

The environmental impact from heat production in breweries may be significantly reduced by changing from combustion of HFO to LFO. In most cases this can be accomplished by exchanging the burners, and in addition preheating of the boiler fuel becomes superfluous.

For a brewery with a beer production of 1,000,000 hl/year and a specific heat consumption of 175 MJ/hl, the reduction in sulphur emission may be assessed as follows:

- Sulphur content in HFO: about 3%
- Sulphur content in LFO: about 0.3%
- Lower calorific value HFO & LFO: about 42,000 kJ/kg
- Boiler efficiency: about 90%

Based on the indicated average data, the sulphur reduction G will be:

$$G = 1,000,000 * 175 * 10^3 * (3 - 0.3) / (42,000 * 0.9 * 10^2) = 125,000 \text{ kg/year}$$

## **5.1.2 Potential BAT's**

### **5.1.2.1 Control of Mashing-in Temperature and Hot Water Balance**

Hot water consumption is one of the key issues in regard to energy savings. Hot water is normally produced in a heat exchanger when cooling down the wort from 100°C to the fermentation temperature (about 10°C). The hot water is stored in insulated (hot) water tanks and used for mashing of the next brew.

If hot water is used for mashing only, there will be an excess of hot water giving an overflow from the hot water tank. Large amounts of water and energy can be lost due to this overflow.

To optimise the hot water system, a hot water balance should be made for the entire brewery. It should carefully be investigated when, where and how much hot water is used. The investigation should also reveal if it is possible to use hot water instead of cold water heated by steam for functions such as CIP, sterilisation and bottle washing.

It is also important that the hot water tank is sized correctly to avoid that the brewery has to produce hot water from steam after a weekend stop in the brewhouse.

### **5.1.2.2 Control and Optimisation of Evaporation Rate**

In order to meet the process requirement for the wort boiling it is required to heat and boil the wort. The wort is transferred from lautering at a specific temperature and a gravity, which varies depending upon the sparging of the mash.

The energy consumption will, therefore, depend upon the gravity and the gravity before and after boiling and the evaporation required to remove unwanted flavour components.

A reduction of 1% of the evaporation rate will result in a 2.2 MJ/hl wort reduction.

In order to reduce the energy consumption 3 options exist:

- Control of the inlet gravity
- Control of the gravity during boiling
- Increase of evaporation efficiency for the unwanted flavour components

By control of the inlet gravity the incentive will be to maintain as small as possible a difference between the gravity from the lautering and the specific

wort gravity. This might cause a decrease in the raw material efficiency, as sparging will cease earlier. See also section 5.3.2.1.

In-line control of the gravity during boiling enables to stop the boiling when the specification has been reached. Excessive boiling is thereby avoided.

Recent development in new brewhouse designs has resulted in brewhouses with significantly reduced evaporation rates. In principle the methods employed increase the stripping / evaporation of the unwanted flavour components, by increasing the surface contact between liquid and gas.

Replacement of brewhouses or the wort boiling equipment is expensive and is normally only feasible when the brewhouse has to be replaced due to other considerations.

### **5.1.2.3 Heat Recovery from Wort Boiling**

Wort boiling is the largest single heat consuming process in a brewery.

When boiling the wort, normally 6 - 10% of the wort is evaporated. The vapour is normally emitted to the atmosphere whereby a lot of energy is wasted and odours unpleasant to the surroundings are produced. By recovering the heat from the wort kettles, energy is saved and odour problems reduced.

A method to recover the heat from the vapour is to use it to produce hot water for various processes and cleaning. This system is found in some breweries. If, however, hot water is also produced during wort cooling (which is very common) there will be an excess of hot water, meaning that hot water will go to drain.

There are two alternative ways in which options to recover vapour:

- Using the vapour to boil the wort. Vapour heated by means of a compressor (steam injector or mechanical compressor) can be used to boil the wort in a special heat exchanger. The heat in the vapour condensate, which will have a temperature of about 100°C can be recovered by producing hot water. This will of course only be done if there is a lack of hot water. For system design, please refer to figure 5.1.
- Using the heat in the vapour to produce 98°C hot water for pre-heating of the wort before wort boiling. The wort can hereby be heated from 72°C to approx. 90°C by means of recovered heat. The system requires installation of an energy store. Also the heat in the vapour condensate can, if required, produce hot water for use in production and for cleaning. For system design, please refer to Figure 5.2.

Figure 5.1 shows a system with conventional wort boiling with steam ejection compressor and condensate cooling.

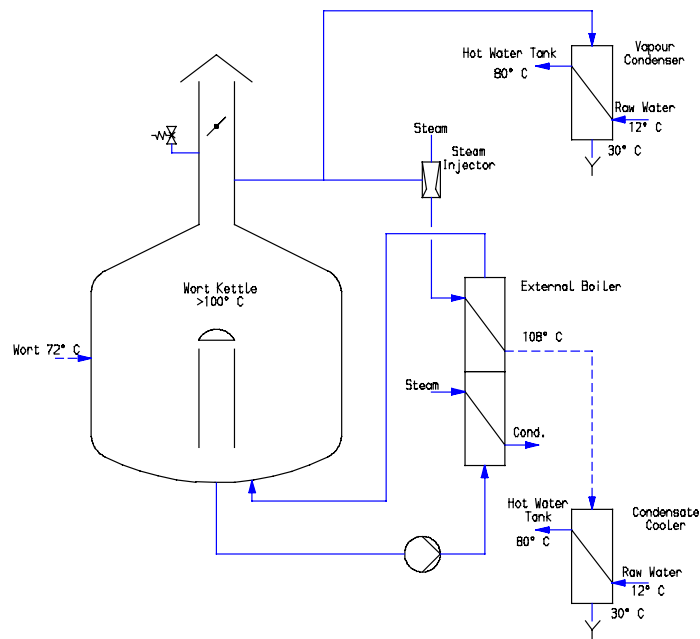

**Figure 5.1: Heat Recovery for Wort Kettle - Steam Ejector**

Figure 5.2 shows a system with conventional wort boiling with vapour condenser, energy store, wort pre-heating and condensate cooling.

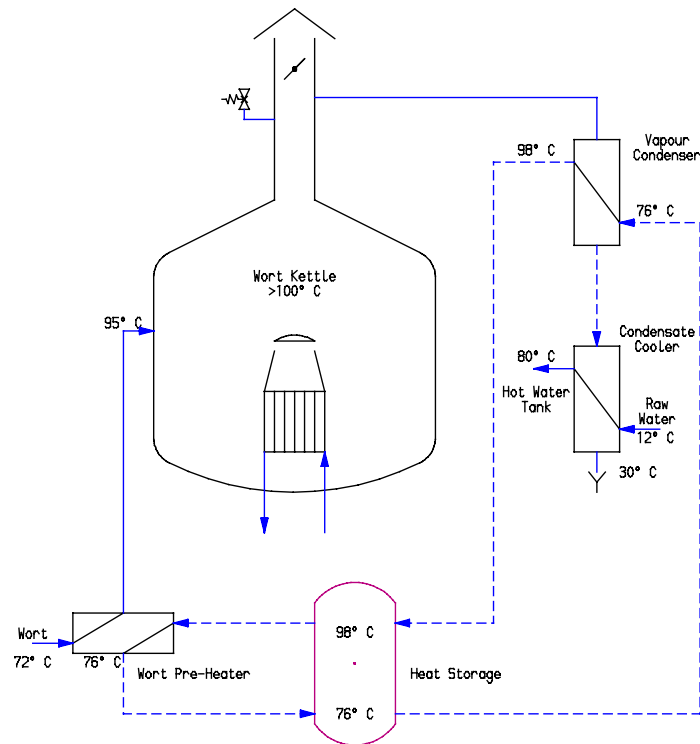

**Figure 5.2: Heat Recovery for Wort Kettle - Wort Pre-heating**

The systems shown are expensive and should therefore be considered together with other significant energy consumption reduction options. In a new brewery, the systems should always be evaluated.

#### 5.1.2.4 Insulation

Insulation of hot surfaces is an effective way to reduce the energy consumption.

The following items should normally be insulated:

- Valves, flanges
- Brew kettles or part of brew kettles
- Tunnel pasteuriser
- Bottle washer
- Part of refrigeration pipe systems
- Pipe connections to machinery

**CASE STUDY: MISSING INSULATION**

The insulation of a 1 metre,  $\varnothing$  89 mm, steam pipe working 6,000 hours per year will provide a saving of about 450 kg oil per year (equal to 18,000 MJ/year).

**5.1.2.5 Cooling Plant**

The evaporating temperature of the cooling plant is often lower than necessary. The requirement from the processes to the cooling plant is that it must be able to cool the beer to about  $-2^{\circ}\text{C}$ . An evaporating temperature of around  $-6$  to  $-8^{\circ}\text{C}$  is sufficient, but often the cooling plant is designed for a much lower evaporating temperature. An increase of  $1^{\circ}\text{C}$  in evaporating temperature will reduce the electricity consumption for the cooling plant with 3 - 4%.

It is also important to design the condensing side of the cooling plant for the lowest possible condensing temperature. The lowest possible condensing temperature will depend on climatic conditions. A decrease of  $1^{\circ}\text{C}$  will reduce the electricity consumption for the cooling plant with about 2%.

Ice Bank technology could be used in order to operate plants more efficiently at night time and to reuse the stored "cold" during peak load periods in order to smooth power requirements.

**CASE STUDY: COOLING WITH DIRECT EXPANSION OF AMMONIA AS OPPOSED TO INDIRECT COOLING WITH GLYCOL.**

A brewery in Europe was going to supplement its tank farm capacity in order to increase production with about 700,000 hls/year as a result of rising sales. For cooling of the new tank farm two options were investigated:

- **Option 1:** Cooling with ammonia by direct expansion in cooling jackets integrated in the tank wall. Ammonia to be supplied by pumps from an ammonia gas/liquid separator. Evaporation temperature about  $-4^{\circ}\text{C}$ . Separate compressors for tank farm.
- **Option 2:** Cooling with glycol in cooling jackets. Supply temperature  $-4^{\circ}\text{C}$ . Main refrigeration plant evaporating temperature:  $-8^{\circ}\text{C}$ .

The peak load was found to about 800 kW, whereas the average cooling load over the entire production year was calculated at 450 kW. The annual running time was set at 5,000 hrs. An interest rate of 8% and an expected life time of

15 years was used in the economical calculations together with local unit costs for power and water.

The investigation revealed that the capital costs for compressors, condensers, pump separator and ammonia piping with valves under Option 1 would amount to about EUR 425,000. The capital costs for Option 2 would be about 15% higher.

The investigation further revealed that the annual operating costs which include costs for power, condenser make-up water and depreciation for Option 1 would amount to about EUR 105,000. For Option 2 the operating costs would be about 25% higher.

As it appears, there was a significant additional cost implication using glycol in lieu of direct expansion of ammonia, but even more important, - the annual running costs were substantially higher.

In addition, there was a significant power saving in Option 1. The overall annual power consumption in Option 1 was calculated to about 577 MWh, whereas the glycol solution, Option 2, resulted in a power consumption at about 819 MWh – an increase of not less than 42%.

#### **5.1.2.6 Compressed Air Plant**

The pressure in the compressed air system should be as low as possible. If the pressure is lowered from 8 bar to 7 bar, the electricity consumption for the compressors will drop 7%.

A heat recovery unit can recover 95% of the electricity consumption for a compressor. However, there are other types of waste heat in a brewery that can be recovered more easily.

#### **5.1.2.7 Motor and Pumps**

Installation of new more efficient equipment and implementation of resource management reduces the electricity consumption.

In a brewery, electricity is used by electric motors. Electrical boilers are normally not used. There are two methods of reducing the electricity consumption for motors:

- Installation of new motors with a higher efficiency.
- The use of motors can be optimised by installation of frequency converters making it possible to control flow and pressure in a more efficient way.

**5.1.2.8 Table of other Potential BAT's**

<b>Description</b>	<b>Environmental effect</b>	<b>Applicability</b>
Condensate recovery and steam leakage.	Loss of 1 m <sup>3</sup> of condensate (85°C) represent the energy in 8.7 kg oil.  Increased water consumption.	Depending upon the actual brewery lay-out and consumption in area without condensate recovery.
Condensing flue gas heat exchanger used for pre-heating of boiler feed water	Energy recovery 5 –7% percentages increase in boiler efficiency.	Heavy fuel oil will require a heat exchanger able to resist the corrosion potential.
Installation of high speed rolling gate in the unloading and loading area	Reduced loss of heat.  Improved working conditions.	Depends upon winter conditions and logistic in the unloading and loading areas.
Heat recovery from air compressor plant	Energy recovery.	Low temperature heat can be used in a 60°C water system.

**CASE STUDY: VAPOURIZING OF LIQUID CO<sub>2</sub> USING SECONDARY REFRIGERANT FROM BREWERY MAIN REFRIGERATION SYSTEM AS OPPOSED TO USING STEAM OR AMBIENT AIR.**

A brewery had decided to install a CO<sub>2</sub> collection plant in order to utilise the CO<sub>2</sub> generated in the fermentation process, thereby avoiding purchase of liquid CO<sub>2</sub> from external suppliers. The existing CO<sub>2</sub> system included vaporisers for steam application. As the brewery refrigeration plant uses a secondary refrigerant, it was decided to investigate the feasibility of using this for evaporation of the CO<sub>2</sub>. By doing this, the capacity of the refrigeration plant was increased corresponding to the amount of latent heat required to vaporise the CO<sub>2</sub>. This, in fact, contributed to a postponement of installation of additional refrigeration capacity.

The study included a comparison of the following 3 heating media:

- Steam
- Ambient air
- Secondary refrigerant from main plant with ambient air CO<sub>2</sub> superheaters.

The vaporising capacity was selected to 2x1,500 kg/h.

The capital and operating costs were assessed as shown in the table below. An interest rate of 6% and a practical lifetime of 10 years were used in the calculations.

	<b>Capital Costs</b>	<b>Operating Costs</b>
	<b>EUR</b>	<b>EUR</b>
<b>Steam</b>	35,000	14,000
<b>Ambient air</b>	47,000	8,900
<b>Secondary refrigerant</b>	67,000	5,200

The study revealed the following annual energy consumption figures:

- Steam: about 620 MWh of heating energy
  - Ambient air: about 16 MWh of power
- Secondary refrigerant and CO<sub>2</sub> superheaters: about 23 MWh of power for the superheater fans, but a saving of about 132 MWh of power for the refrigeration compressors.

Based on the comparison it was decided to install the vaporisers using secondary refrigerant, - supplemented by fan-driven ambient air superheaters.

### **CASE STUDY: STEAM LEAKAGE**

A leakage that gives a weak hissing sound and a hardly visible cloud of steam, for instance a leaking steam valve, can result in a loss of approx. 1 kg steam per hour, corresponding to a fuel consumption of approx. 700 kg oil per year.

A leakage that gives a visible cloud of steam and a hissing sound, for instance a leaking seal, gives a loss of 3-5 kg steam per hour, corresponding to a fuel consumption of 2,100 - 3,500 kg oil per year.

**CASE STUDY: LEAKAGE LOSSES - COMPRESSED AIR**

(Pressure: 6 bar)

Hole Size	l/s	kWh/day corresponding electricity consumption	MWh/year corresponding electricity consumption
mm			
1	1	6.2	2.6
3	19	74.4	27.0
5	27	199.0	73.0

**5.2 Water****5.2.1 Selection of Priorities**

The following subjects have been identified as being of priority in order to minimise the environmental impact of water consumption:

- Water management including benchmarking of the specific water consumption.
- Assessment of whether a secondary water source may be available and used as e.g. technical water.
- Assessment of risk for pollution of ground and surface water sources.
- Assessment of potential BAT's

**5.2.2 Potential BAT's****5.2.2.1 Hot Water Balance**

For the description see section 5.1.

Typically the cooling of 1 hl wort requires 1.1 hl of ice water, which will be drained if the hot water tank is full.

Therefore, the surplus hot water - which almost always is the result of the brewhouse operation – should be used elsewhere in the brewery if possible and the hot water tanks should be designed to allow for temporary overproduction of hot water from the wort cooling.

### **5.2.2.2 Collection of Last Rinsing Water**

For saving of water, a tank for collection of last rinsing water should be installed. The last rinsing water can be reused as first rinsing water for the next CIP cycle.

### **5.2.2.3 Bottle Washer**

A bottle washer uses clean water to cool the bottles and to rinse the caustic from the bottles in the last zone of the washer.

To minimise water consumption of a bottle washer, the rinsing zone should be optimised. It should be noted that new modern bottle washers have a much lower energy and water consumption than older machines. (The water consumption for a modern bottle washer is around 0.5 hl/hl bottle volume. Water consumption figures of 3 - 4 hl/hl bottle volume are not unusual in the case of older bottle washers.)

The limiting factor for reduction of water consumption for a bottle washer is the temperature of the bottles coming from the bottle washer. Too high a bottle temperature will lower the efficiency of the filler.

In general, it is not possible to prescribe how to reduce the water consumption for an existing bottle washer or to say whether it is possible to reduce it. This depends on how the washer is constructed.

The following should be considered:

- Installation of an automatic valve to interrupt the water supply when there is a line stop.
- Installation of more effective rinsing nozzles, using less water.
- Control of the rinsing water flow. Often the flow is much higher than specified or may vary due to pressure fluctuations in the water supply system.
- Use of fresh water for the two last rows of rinsing nozzles. This rinsing water should be collected and used for the other rinsing nozzles.

#### **5.2.2.4 CIP – Cleaning in Place**

The internal cleaning of process equipment involves the use of a lot of water, energy and detergent.

The design of CIP plants can vary very much. From simple systems where a batch of cleaning solutions is prepared and pumped through the system and drained, to fully automatic CIP plants consisting of tanks for water and cleaning solutions making it possible to reuse some water and cleaning solutions.

Acid cleaning is normally used for process tanks where CO<sub>2</sub> has been generated or used as top pressure. Caustic is used for pipework and the occasional tank cleaning to remove proteinaceous material. Where both acid and caustic CIP systems are in use, waste agents from the two systems can be blended using an effluent balance tank to help neutralise the discharge.

It is important to optimise the CIP plants and the procedures to make sure that unnecessary losses of water and detergent are avoided. A CIP plant, which is not working properly, may lose a lot of water and detergent.

Systems for cleaning out contaminated CIP streams are being developed and evaluated in some breweries.

#### **5.2.2.5 Pasteuriser**

In the tunnel pasteuriser the beer and bottles are slowly heated up to the pasteurisation temperature and afterwards slowly cooled down to an outlet temperature of about 30 - 35°C.

In many cases the cooling of the beer is done by means of fresh water in an open loop system, resulting in a very high water consumption. Instead, a closed loop system should be evaluated. In a closed loop system the water is recirculated via a cooling tower and possibly via a cooler connected to the central refrigeration plant, i.e. chilled and returned to the tunnel pasteuriser. In this way the consumption of fresh water for the tunnel pasteuriser is reduced considerably being restricted to make-up water, due to evaporation and bleed-off is necessary. To prevent algae and growth of microorganisms, additives are injected to the water recirculating system.

The recycling system can often reduce the water consumption for the tunnel pasteurisers by 80%.

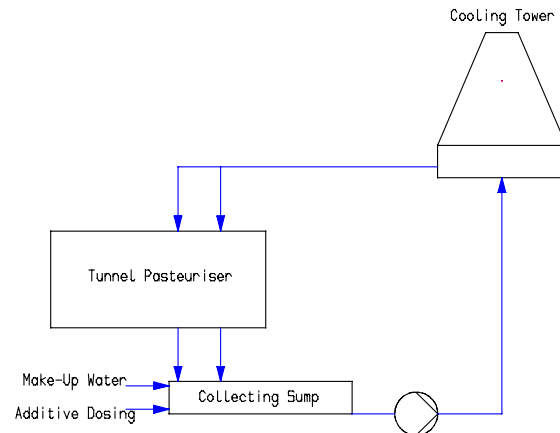

**Figure 5.3: Cooling Tower System for Tunnel Pasteuriser**

It should be noted that a modern tunnel pasteuriser with a sufficient number of regenerative zones has a much lower energy and water consumption than older machines.

#### **CASE STUDY: INSTALLATION OF COOLING TOWER FOR TUNNEL PASTEURISER**

A brewery using an open loop cooling system for the tunnel pasteuriser installed a cooling tower to change the system to a closed loop system.

Reduction in water consumption: 50,000 m<sup>3</sup>/year

#### **5.2.2.6 Vacuum Pump**

In connection with the bottle filler, "air tube with pre-evacuation" type, a vacuum pump is used to evacuate air from the bottles before filling.

Normally, a liquid ring type vacuum pump is used. This type of pump is continuously supplied with water to replace the water that is being thrown out through the discharge outlet, together with the air. If no recirculation tank is installed, the vacuum pump will have a high water consumption.

Installation of a recirculation tank will reduce the water consumption by approximately 50%. The investment will be minor and should be evaluated.

**5.2.2.7 Table of Other Potential BAT's**

<b>Description</b>	<b>Environmental effect</b>	<b>Applicability</b>
Supply of water to crate washer from bottle washer.	Reduced water consumption saving of energy to heat water.	Depend upon colour of crates.
High pressure cleaning of floor.	Reduced water and chemical consumption.	
Installation of containment basins for oil and chemicals.	Reduced risk for contamination of ground and surface water sources.	Many countries have specific requirements that have been implemented.
Preparation of contingency measures to collect spillage of oil and chemicals.	Reduced risk for contamination of surface water sources.	For breweries with separate rainwater sewer in areas where surface water is used as drinking water.

**5.3 Wastewater****5.3.1 Selection of Priorities**

The following subjects have been identified as being of priority in order to minimise the environmental impact of wastewater discharge:

- Meeting effluent requirements
- Ensure efficiency of wastewater treatment
- Reduce wastewater discharge from the brewery
- Collection and recovery of product and by-products

**5.3.2 Potential BAT's****5.3.2.1 Collection of Weak Wort**

After the wort has been strained off, the grains contain large quantities of extract that must be recovered in order to reduce the loss. The residual extract is recovered by washing out the grain bed with sparging water. The wort strength will decrease during this last part of the straining. The draw-off is stopped when the desired wort strength has been reached in the wort kettle.

The remaining wort in the lauter tun will still have a low content of extract and is called weak wort. If the weak wort is drained to the sewer system, the COD load in the wastewater will increase and, obviously, extract is lost.

Weak wort can be collected in a tank equipped with heating jackets and a slow speed agitator and used for mashing in the next brew. This is particularly important for high gravity brewing. It reduces the organic load in the wastewater and will save raw material and water.

The COD value of weak wort is around 10,000 mg/kg. The weak wort volume is 2 - 6% of the wort volume and 1 - 1.5% of the weak wort is extract. Collection of the weak wort will therefore reduce the wastewater load with 20 - 60 g/hl wort produced.

#### **5.3.2.2 Trub to Brewers Grains**

Trub is a slurry consisting of wort, hop particles and unstable colloidal proteins coagulated during the wort boiling. The trub slurry is separated from the wort prior to wort cooling for instance in a whirlpool.

The trub contains wort. The extract loss related to the trub will depend on how efficiently the wort and trub are separated.

The trub suspension can be treated in different ways, added to the brewers grains or sent directly to the sewer system. To minimise the COD load and the extract loss, discharge of trub to the sewer system should be avoided.

The trub can be returned to the mash kettle or lauter tun / mash filter. Hereby the trub forms part of the brewers grains and can in this way be utilised as animal fodder. If the trub is added before or during lautering the extract in the trub is recovered as well, however this could have a negative effect on the beer quality.

The COD value of trub is around 150,000 mg/kg wet trub. The amount of trub from a well-functioning whirlpool is 1 - 3% of the wort volume (in the whirlpool in cases of insufficient whirlpool function even higher) with a dry matter content between 15% and 20%. The reduction in wastewater load by returning the trub is therefore 150 - 450 g COD/hl wort.

#### **5.3.2.3 Collection of Yeast**

Excess yeast is produced during the fermentation process. Only part of the yeast can be reused as new production yeast.

It is important to collect as much surplus yeast as possible to avoid high COD discharge to the sewer system. Yeast can be collected from fermentation and storage tanks, the yeast storage plant and from the filter line.

The amount of this surplus and spent yeast slurry is 2 - 4 kg (10 - 15% dry matter content) per hl produced beer. The yeast suspension contains yeast and beer and has a very high COD value (180,000 - 220,000 mg/litre). Very often the yeast or part of it is sent to the wastewater. The total COD load for the brewery will therefore be reduced with approx. 360 - 880 g COD/hl beer, if all yeast is collected instead of being led to the sewer system.

#### **5.3.2.4 Collection of Residual Beer**

Residual beer is lost through the different production stages.

The main sources of residual beer are:

- Emptying of process tanks. After the tanks are emptied some beer will remain. The amount depends on the efficiency with which the emptying is controlled.
- Kieselguhr filter. At the beginning of a filter run the filter will be full of water that is pushed out with beer. At the end of a filter run the beer is pushed out with water. These pre-runs and after-runs result in a mixture of beer and water.
- Pipes. When beer in the process pipes is pushed out with water, a mixture of water and beer will occur.
- Beer rejected in the packaging area. Beer can be rejected due to for example wrong filling height and no or incorrectly placed labels. The number of rejected bottles will depend on the brewery's quality requirements and the equipment.
- Returned beer. Beer may be returned to the brewery if it has not been sold or if the quality is not acceptable.
- Exploding bottles in the packaging area. The bottles explode due to poor quality of the bottle, poor bottle inspection or lack of temperature control in the tunnel pasteuriser.

Most of the residual beer can be collected and reused in the processes. The part not collected is discharged to the sewer system giving a raw material loss and a high COD load of the wastewater. However, process equipment and quality requirements may limit the applicability for residual beer recovery.

The amount of residual beer should be minimised through process changes, especially in regard to the emptying of tanks. The operator should make sure the tanks are as close to empty as possible before cleaning. Through good housekeeping and an efficient monitoring system, only residual beer that cannot be removed will remain.

The COD value of beer is around 120,000 mg/kg depending on its strength and alcohol content. The total amount of residual beer will be in the area 1 - 5% of the total production, sometimes higher. A reduction of 1% in loss of residual beer to the sewer system will result in a reduction in the wastewater load of 120 g/hl beer.

#### 5.3.2.5 Table of Other Potential BAT's

Description	Environmental effect	Applicability
If the brewers grains are poorly drained before transfer to the brewers grains silo, weak wort will go into the wastewater from the brewers grains silo.  Prolongation of the last running of period.	Reduced wastewater load and extract loss.	
Optimisation of raking.	Reduced wastewater load.	
Avoid overfilling of fermenters causing beer to be lost with the foam.	Reduced wastewater load and extract loss. Increased cleaning of CO <sub>2</sub> collection system.	Depends on pressure control of tank park.
Collection and reuse of rinsing water.	Reduced wastewater load.	
Sedimentation of caustic from the bottle washer.	Fluctuation in wastewater pH when the caustic is dumped will occur to a lesser extent.	Cost of caustic and energy caustic replacement procedure.
Usage of Hazard Analysis Critical Control Point (HACCP)	Identification of processes leading to discharge of product and detergents.	Used from a food safety perspective.

## **5.4 Solid Waste**

### **5.4.1 Selection of Priorities**

The following subjects have been identified as being of priority in order to minimise the environmental impact of solid waste generation:

- Operation of a reliable by-product programme
- Avoid potential waste from entering the brewery
- Minimise solid waste generation
- Recycle
- Compliance with solid waste regulations

### **5.4.2 Potential BAT's**

#### **5.4.2.1 Kieselguhr**

If treatment is not used at the brewery, centrifuging the beer prior to filtration can reduce kieselguhr consumption. With a highly efficient centrifuge up to 98 - 99% of the yeast remaining in the beer is removed.

Implementation of a centrifuge will have the following effects:

- Reduction in the amount of kieselguhr that needs to be dosed during filtration
- Prolongation of the filter runs
- Improved utilisation of the kieselguhr filter
- Reduction in water consumption for back-washing of filter
- Minimisation of problems with handling of wet kieselguhr
- Minimisation of problems with handling of dry kieselguhr
- Possibility to collect more surplus yeast

However, the installation of a centrifuge is expensive and its operation requires considerable electricity.

Prior to investing in a centrifuge there are other factors to consider in order to promote yeast settling and thereby reduce kieselguhr consumption. The factors are:

- The selection of malt
- Optimum brewhouse procedures
- Use of flocculent yeast strains
- Well designed storage and transfer equipment
- Long storage periods

## **5.5 Noise**

### **5.5.1 Selection of Priorities**

The following subjects have been identified as being of priority in order to minimise the environmental impact of noise from the brewery:

- Registration and follow up on noise complaints.
- Assessment of activities during noise sensitive periods e.g. night times and weekends.
- Regular inspection and preventive maintenance of outdoor equipment which might cause large noise emission if malfunctioning.

## **5.6 Odour**

### **5.6.1 Selection of Priorities**

The following subjects have been identified as being of priority in order to minimise the environmental impact of odour from the brewery:

- Registration and follow up on odour complaints.
- Assessment of activities that might cause odours e.g. by-product storage during the summer period.
- Regular inspection and maintenance of containment measures in area that can cause odours e.g. oil tanks and wastewater installations.

### **5.6.2 Potential BAT's**

#### **5.6.2.1 Heat Recovery from Wort Boiling**

By the condensation of vapours from the wort boiling the most significant odour source from the brewing process will be eliminated.

For further information and description see section 5.1.2.3.

## **5.7 Dust**

### **5.7.1 Selection of Priorities**

The following subjects have been identified as being of priority in order to minimise the environmental impact of dust from the brewery:

- Registration and follow-up on complaints.
- Regular inspection and maintenance of dust abatement equipment.

## **5.7.2 Potential BAT's**

### **5.7.2.1 Re-use of Malt and Adjunct Dust**

Malt and adjunct dust represents a loss of extract. If collected it can be conveyed to the mash or adjunct kettle and the extract recovered.

The dust should, therefore, be collected in connection with unloading of malt and adjunct and from the pneumatic transport of malt / adjuncts.

The application of malt / adjunct dust re-use is limited to brewhouses with mash filters as the insoluble parts of the dust otherwise will not be removed from the wort.

As an alternative the dust may be used for animal fodder.

## **5.8 Risk Activities**

### **5.8.1 Selection of Priorities**

The following subjects have been identified as being of priority in order to minimise the environmental impact of risk activities at the brewery:

- Compliance with safety regulations.
- Regular inspection, calibration and maintenance of equipment related to the risk activities.

### **5.8.2 Potential BAT's**

#### **5.8.2.1 Table of Other Potential BAT's**

<b>Description</b>	<b>Environmental effect</b>	<b>Applicability</b>
Usage of Hazard and Operability studies (HAZOP)	Limits risk for accidents.	Mainly applicable for new plant and installations and changes to existing plant and processes

## **5.9 Raw Materials**

### **5.9.1 Selection of Priorities**

The following subjects have been identified as being of priority in order to minimise the environmental impact associated with poor raw materials utilisation:

- Raw materials management e.g. calculation of extract loss, brewhouse
- Quality control of raw materials
- Quality control of packaging materials
- Residual beer recovery
- Recovery of extract from by-products

### **5.9.2 Potential BAT's**

#### **5.9.2.1 Malt / Brewers Grains**

For the production of one hectolitre of a normal Lager beer about 15 kg of brewing material (malt and adjunct) are used. Normally not more than 30% of the brewing material is adjunct.

The consumption of raw material depends on the beer type produced (wort strength) and on extract losses in the different production areas.

Brewers grains are the residual solids remaining after separation of the mash into wort and brewers grains. The brewers grains contain residual extract and water. The amount of brewers grains is normally 19 litres per hl wort with a water content of 80%.

In a well-designed and well functioning brewhouse, the difference between the actual yield and the laboratory yield should be less than 1%. Often the difference will be higher meaning that extract is lost through the brewers grains.

If the difference between the actual brewhouse yield and the laboratory yield from malt is higher than 1%, extract will be lost with the brewers grains, meaning that the raw materials are badly utilised.

The reasons for a poor brewhouse yield are:

- Poor malt quality
- Unsatisfactory crushing of the malt in the mill
- Unsatisfactory mashing process
- Poor design of lauter tun / mash filter

- Incorrect operation of lauter tun / mash filter

To improve the brewhouse yield, an analysis must be carried out to find the reasons for the loss. The corrections to improve the brewhouse yield may go from change of process to adjusting the mill and / or to renewing the equipment.

By reducing the raw material loss by 1%, a saving of about 0.2 kg malt raw material per hl beer is achieved. Furthermore, less raw materials and intermediate products need to be processed in different stages of the process causing consumption of resources, i.e. the usage of energy and water and generation of wastewater, solid waste and nuisance are reduced.

The brewers grains is a valuable by-product, and the simplest and most common way to handle it is to sell it in a wet condition as fodder. The brewers grains are not storage-stable, and will putrefy very quickly for which reason the brewers grains must be sold the same day they are strained. If this is not possible, the brewers grains can be dried to become storage-stable. Drying, however, requires heat.

#### **5.9.2.2 Weak Wort**

See section 5.3.2.1.

#### **5.9.2.3 Trub**

In section 5.3.2.2 it was described that the extract in the trub is recovered if the trub is added before or during lautering.

Alternatively wort can be recovered by installing a centrifuge or a decanter to separate the remaining wort from the hot trub. The recovered wort is returned to the main wort and the solids are added to the brewers grains. The trub volume can hereby be reduced to a range of about 0.2 - 0.5% of the wort.

The profitability and the effect of minimising the loss of the system will very much depend on how the whirlpool is functioning. A well-functioning whirlpool will leave a trub with a quite high dry matter content, and therefore the loss is small. In whirlpools with for instance a trub cone, the loss will, however, be high.

#### **5.9.3 Yeast**

As mentioned in section 5.3.2.3, yeast can be collected from fermentation and storage tanks, the yeast storage plant and from the filter line.

The yeast collection system may include a centrifuge, yeast storage tanks, pipes and pumps.

The yeast suspension contains a large amount of beer. A brewery loses about 1 - 2% of the beer production with the yeast. The beer can be recovered and recycled. To recover beer from yeast, the following equipment may be used:

- Centrifuge
- Cross flow filter
- Press filter

Recovered beer is added to the hot wort in the brewhouse or pasteurised and blended into the fermentation tanks.

The recovery of beer from the yeast is a rather expensive process, and it is only profitable for large breweries.

Surplus yeast can be utilised in several ways:

- Yeast suspension can be sold for animal feed, e.g. to pig farms. It contains large amounts of protein and vitamins as well as carbohydrates, fat and minerals.
- In areas with few farmers or with little need for it, selling all the yeast may be difficult. Furthermore, the shelf life of the yeast suspension is limited. In this case the yeast should be dried for storage. The dry yeast can be sold as fodder or for human consumption. It should, however, be noted that drying of yeast requires considerable heat.

#### **5.9.4 Residual Beer**

As mentioned in section 5.3.2.4, discharge of residual beer to the sewer system will cause valuable extract to be lost.

How the beer can be recycled will depend on the quality of the residual beer. High-quality residual beer can be collected and dosed directly into the beer flow in the filter line. Other residual beer (which might have been oxidised) has to be returned to the whirlpool or the fermenters after pasteurisation.

Other residual beer will normally be beer from the packaging area. High quality beer, e.g. pre- and after-run beer can be obtained from the other sources depending on the process plant.

A system for collection and recycling of residual beer will consist of pipes and pumps for collection, beer storage tanks and dosing pipes and equipment.

**5.9.5 Table of Other Potential BAT's**

<b>Description</b>	<b>Environmental effect</b>	<b>Applicability</b>
If the brewers grains is poorly drained before transfer to the brewers grains silo, weak wort will go into the wastewater from the brewers grains silo.  Prolongation of the last running-off period.	Reduced extract loss and wastewater load.	
Avoid overfilling of fermenters causing beer to be lost with the foam.	Reduced extract loss and wastewater load.	

## **6. End of Pipe Techniques**

The major waste streams from breweries as described earlier are wastewater and solid waste. Treatment / disposal methods for these two waste streams will be discussed in this chapter. Applicable methods related to energy, water, noise, odour, dust and risk activities are described.

### **6.1 Energy**

Techniques applied in the brewing industry to reduce the air emission from the energy production does not differ significantly from those used in the Food, Drink and Milk industry in general. Reference is therefore made to the BREF for the Food, Drink and Milk industry.

### **6.2 Water**

In relation to avoid contamination of water sources it is relevant for the brewery to assess if sufficient pollution containment and contingency measure are available.

For breweries located on top of drinking water aquifers caution must be made to avoid the contamination of the ground water with oil and chemicals.

For breweries with rainwater discharge to surface waters, which are used for drinking water supply, caution is required to avoid spillage of oil and chemicals on the outdoor paved surfaces. Contingency measures such as covers for the drains should be available in order to avoid e.g. chemical spillage to enter the rainwater system.

### **6.3 Wastewater Treatment**

Brewery wastewater generally has a high content of organic material. This section describes treatment of the wastewater to reduce the influence of this organic material on the receiving waters.

The brewery wastewater and the corresponding treatment will be described in the following sections:

- Characteristics of brewery wastewater
- Pre-treatment
- Anaerobic treatment
- Aerobic treatment

The possibilities for a combined treatment of municipal and brewery wastewater are addressed in the sections.

### **6.3.1 Characteristics of Brewery Wastewater**

Wastewater from breweries may be divided into three types:

- Process wastewater from the production
- Sanitary wastewater from toilets and kitchens
- Rainwater

This section will focus on the process wastewater. The sanitary wastewater will only contribute with a small loading, both measured as organic material and as flow, but will require attention in regard to the clogging of pumps and screens.

It is recommended that the rainwater be discharged into a separate drainage system as the flow during rain can interfere with the operation of the WasteWater Treatment Plant (WWTP).

The process wastewater flow from a brewery will depend on the production and the specific water usage.

The peak flow will be in the order of 2.5 - 3.5 times the average flow, depending on how close to the production area the measurement is made. The period of peak flow is normally short. Peak flows occur in the brewhouse and beer processing area in connection with cleaning operations. In the packaging area, peak flows occur during closing down of the line as bottle washers and tunnel pasteurisers are emptied. A third area, where large peaks can occur, is in the water treatment area during backwash of filters.

The concentration of organic material will depend on the wastewater to beer ratio and the discharge of organic material into the sewer. The concentration of organic material is usually measured in COD (Chemical Oxygen Demand) or in BOD (Biological Oxygen Demand). If not otherwise indicated, BOD is measured for a 5-day period. The typical discharge of organic material from a brewery is varying but is normally in the range of 0.8 – 2.5 kg COD/hl beer. Larger discharges can occur and can be attributed to discharge of surplus yeast, trub or other concentrated wastes into the sewer that could be disposed of in better ways. Production of non-alcoholic beer may result in very high discharges if the condensed alcohol is discharged into the sewer.

Normally, the process wastewater has a low content of non-biodegradable components. Brewery wastewater normally has a COD / BOD ratio of 1.5 - 1.7 indicating that the wastewater is easily degradable. Bio essays, such as

Activated Sludge Oxygen Consumption Inhibition Test, usually show that the respiration is increased compared to that of ordinary municipal wastewater.

The discharge of suspended solids (SS) is in the range of 0.2 - 0.4 kg SS/hl beer. Discharge of mash, yeast, kieselguhr and paper pulp will increase this ratio significantly.

Nitrogen (N) is often in the range of 30 - 100 g N/m<sup>3</sup>. Nitrogen will come from the malt and adjuncts. Nitric acid used for cleaning may contribute to the total nitrogen content. Nitrogen will often be deficient for aerobic treatment of the process wastewater and has to be added. The actual concentration will depend on the water ratio, amount of yeast discharged and the cleaning agents used.

Phosphor (P) can come from the cleaning agents used in the brewery. The phosphor concentrations may vary but are usually in the range of 30 - 100 g P/m<sup>3</sup>. As for the nitrogen the actual concentration will depend on the water ratio and the cleaning agents used.

The concentration of heavy metals is normally very low. Wear of the machines, especially conveyors in the packaging lines, can be a source of nickel and chrome.

Water to beer ratio	4 - 10 hl water/hl beer.
Wastewater to beer ratio	1.3 – 1.8 hl/hl less than water to beer ratio
COD	0.8 – 2.5 kg COD/hl beer
Suspended solids	0.2 - 0.4 kg SS/hl beer
COD / BOD	1.5 - 1.7
Nitrogen	30 - 100 g/m <sup>3</sup> wastewater
Phosphor	30 - 100 g/m <sup>3</sup> wastewater
Heavy metal concentration	Very low

**Figure 6.1: Characteristics of Brewery Wastewater**

### 6.3.2 Pre-treatment

The purpose of pre-treatment of process wastewater is to reduce the risk of harm to the sewer system and to secure working conditions for sewer workers downstream. Furthermore, the pre-treatment is incorporated for operational reasons of the preceding treatment either taking place at the brewery or at a municipal WWTP.

The common pre-treatment is neutralisation of the process wastewater. The neutralisation can take place:

- in production areas
- in central neutralisation tanks with acid / caustic
- by CO<sub>2</sub> neutralisation
- by biological neutralisation

In the production areas the spent detergent can be neutralised by dosing of acids or caustics into the tank before discharging the waste to the sewer. The acid or caustic used for neutralisation could be another used detergent. Other alternatives for neutralisation in the production areas are using surplus CO<sub>2</sub> for the neutralisation of caustic in CIP plants or of overflow from bottle washers.

The central neutralisation of process wastewater requires a tank with a hydraulic retention time of approximately 20 minutes. The mixing capacity should be sufficient to keep the tank completely mixed. The dosing capacity of the neutralisation plant will depend on the operation of the brewery, especially procedures concerning discharge of the caustic baths in the bottle washers and CIP tanks should be considered in the design.

It is possible to neutralise caustic wastewater by using flue gasses from the boiler plant or CO<sub>2</sub> from the fermentation process. The neutralisation plant can be in the form of a scrubber or a simpler system with venting of the gas to a sump.

Since both caustic and acidic cleaning agents are used at the breweries, reduction in chemical usage for neutralisation can be obtained by increasing the hydraulic retention time in the neutralisation tank. Neutralisation tanks are often also used as equalisation tanks with a hydraulic retention time of 3 - 6 hours.

Partial neutralisation through biological conversion will normally take place in process wastewater. It has been observed that the pH in equalisation tanks can drop without addition of acids due to the hydrolysis of organic material. The effect is difficult to control but will reduce the dosing requirements of acid to caustic process wastewater. In order to achieve biological acidification the hydraulic retention time shall be 3 - 4 hours.

### **6.3.3 Anaerobic Treatment**

The treatment of process wastewater in an anaerobic reactor converts the organic material to methane (CH<sub>4</sub>) and CO<sub>2</sub>. Compared to aerobic treatment,

which is the alternative treatment method for reduction of COD, anaerobic treatment has the following advantages / disadvantages:

<b>Advantages</b>	<b>Disadvantages</b>
High loading of reactor volume. Reduced structural and area requirement.	Process sensitive to temperature, pH and loading.
Less energy consumption. The process produces biogas.	Effluent will require further treatment before discharge to recipient.
Smaller sludge generation. Reduced disposal cost.	Longer start-up period.
Limited nutrient addition.	Potential for odour problems.
	More advanced operation and control is necessary.

**Figure 6.2: Advantages / Disadvantages - Anaerobic Treatment**

Loading of anaerobic treatment plants is in the range of 5 - 10 kg COD/m<sup>3</sup>/d for the Upflow Anaerobic Sludge Bed (UASB) types and 15 - 25 kg COD/m<sup>3</sup>/d for the Expanded Anaerobic Sludge Bed (EASB) types. The sludge generation is typical in the order 0.04 - 0.08 kg SS/kg COD removed. The effluent concentration for a plant in stable operation is in the range of 100 – 500 g COD/m<sup>3</sup>. It is not possible to discharge effluent with these concentrations to receiving waters and further treatment is, therefore, necessary.

#### **6.3.4 Aerobic Treatment**

Aerobic treatment of organic material is the conversion into CO<sub>2</sub> and sludge (biomass). The conversion is done with O<sub>2</sub> supplied to the reactor tank, either mechanically or by diffusion from the atmosphere.

The most common and applicable method for the treatment of process wastewater is normally activated sludge systems. Within the category of activated sludge WWTP there are different types of plants. The main difference is the loading of the oxidation tanks going from high loading to extended aeration.

The efficiency of an aerobic WWTP will depend on a number of environmental conditions such as the content of easily degradable organic compounds, temperature, pH, oxygen concentration and nutrient concentration.

At a temperature range of 25 - 35°C, activated sludge WWTP can be loaded with 1.2 - 1.8 kg COD/m<sup>3</sup>/d and obtain an effluent quality of 15 - 25 g BOD/m<sup>3</sup>. However, the winter conditions in Europe and the cooling through the WWTP must be considered in the design. The degradation of the organic material will result in the generation of sludge. Typical sludge generation will be in the order of 0.45 - 0.55 kg SS/kg BOD removed.

A frequent problem with activated sludge plants for brewery wastewater is the build-up of a filamentous biomass which can result in excess of suspended solids in the effluents and in worst case a sludge wash-out. The formation of filamentous sludge can be reduced by introduction of selector tanks, which promotes biomass with good settlement characteristics.

The separation of sludge and treated process wastewater (effluent) is performed in a sedimentation tank. Normal loading of the sedimentation tank is in the range of 0.5 - 1.0 m<sup>3</sup>/m<sup>2</sup>/h. The acceptable loading will depend on the sedimentation characteristics of the sludge. An efficient sedimentation tank can secure a concentration of suspended solids in the effluent of 20 - 30 g SS/m<sup>3</sup>.

The excess sludge can be a significant part of the breweries' solid waste generation and must be disposed of. The sludge can normally be used in land application since the content of heavy metals is low. However, land application has become more and more problematic. Waste regulations shall always be observed.

If effluent requirements are more stringent than a BOD of 15 g/m<sup>3</sup> and an SS of 20 - 30 g/m<sup>3</sup>, further treatment will usually be necessary. It will often comprise the installation of sand filters to remove the suspended solids, as the soluble BOD is very low after extended aerobic treatment.

## **6.4 Solid Waste Handling**

The most important parameter in solid waste handling is the possibility of separating the waste into different waste categories. In the breweries, most solid waste can be reused or recycled as by-products.

In the following, the different categories of solid waste will be described and handling methods identified.

For breweries using returnable bottles, a large portion of the overall brewery waste will be broken glass from the bottling halls. It is possible to recycle the broken glass in the production of new glass at a glassworks, but it is required that the broken glass is relatively free of other materials such as metals and paper. As an alternative, broken glass can be disposed of at landfills. Caution is required in the handling of the broken glass.

Kieselguhr from the filtration of beer also constitutes a very large category. Different methods for regeneration are under development, but presently they are not capable of totally replacing new kieselguhr. The handling of kieselguhr for disposal is therefore limited to increasing the solid content by pressing and disposing at sanitary landfills. In some areas, disposal on farmland can be an alternative. Utilisation in building materials is also possible.

Label pulp from the washing of returnable bottles can be disposed of by composting or recycled into new paper mass. Otherwise the label pulp must be disposed of at sanitary landfills. The paper pulp may contain caustic liquid and heavy metals from label ink.

Breweries using one-way packaging materials such as cans and one-way bottles usually generate large amounts of plastic and cardboard waste. Both the plastic and cardboard should be separated for recycling.

For the rest of the solid waste from breweries, the best applicable handling method is source separation in order to sort out paper, cardboard, metals and wood. In a separated form, most of this waste can be recycled into new material or burned.

Wasted oil from the energy centre and metal shops is a more problematic type of waste. The laboratories will generate waste chemicals from the analyses. Both types of waste must be separated and handled in facilities outside the brewery. Caution should be taken in the storage of these wastes at the brewery. The availability of chemical waste handling facilities is normally the responsibility of the local administration.

## **6.5 Noise**

The main stationary noise-emitting source of a brewery will be the raw material transport, condensers for the cooling plant and cooling towers.

Insulating the external transport routes with sound absorbing material can reduce the noise from the raw material transport.

Condensers and cooling towers may be equipped with silencers on the air intake and outlet and with low-noise motors and fans.

Methods for reduction of the noise emission for other source are described in the BREF for the Food, Drink and Milk industry.

## **6.6 Odour**

In order to limit the odour emission from a brewery the installation of a heat recovery system from the wort boiling is considered as being the most efficient.

Alternative methods for the brewing industry do not differ from those of the Food, Drink and Milk industry. Reference is made to the BREF for the Food, Drink and Milk industry.

## **6.7 Dust**

In general the containment of dust e.g. in connection with raw materials and kieselguhr delivery must have top priority attention. Many different types of containment equipment are available in order to reduce the dust emission by the unloading or opening of bags.

In order to avoid emission of dust, cyclones and bag filters are normally used. For further description of these techniques reference is made to the BREF for the Food, Drink and Milk industry.

## **6.8 Risk Activities**

The possibilities for “end of pipe techniques” for risk activities are limited to the establishing of contingency measures and emergency plans that assess the potential environmental impact and methods to mitigate this if an accident occur.

It is important that legal requirements are followed and that personnel are trained both in handling the situation and in the co-operation with local emergency teams.

**7. Cross Reference to “BREF”**

<b>Section</b>	<b>Title</b>	<b>To BREF</b>	<b>From BREF</b>
<b>2.</b>	<b>Description of the Brewing Processes</b>		
2.1	Production Processes	2.3.15	
2.1.1	Wort Production	2.3.15	
2.1.2	Fermentation / Beer Processing Area	2.2.4.4 2.3.15	
2.1.3	Packaging	2.2.8.1	
2.3	Utilities		2.2.9.2 2.2.9.3 2.2.9.5
<b>3.</b>	<b>Environmental Impact</b>	3.7.15	
<b>4.</b>	<b>Resource Consumption and Emissions</b>	3.7.15	
<b>5.</b>	<b>Best Available Techniques</b>	5	
5.1	Energy	4.8.3.9	
5.2	Water	4.5.4	
5.3	Wastewater		
5.4	Solid Waste	4.3.14.1	
5.5	Noise	4.17.5.1	
5.6	Odour	4.8.3.9	
5.7	Dust		

<b>Section</b>	<b>Title</b>	<b>To BREF</b>	<b>From BREF</b>
5.8	Risk Activities		
5.9	Raw Materials		
<b>6.</b>	<b>End of Pipe Techniques</b>		
6.1	Energy		4.11
6.2	Water		
6.3	Wastewater Treatment	4.14	
6.4	Solid Waste Handling	4.16	
6.5	Noise		4.17
6.6	Odour		4.12
6.7	Dust		4.11
6.8	Risk Activities		

## 8. References

The following references have been used in the elaboration of this Guidance Note:

- UNEP/IE. Technical Report No. 33. Environmental Management in the Brewing Industry.
- Information Exchange on Best Available Techniques (BAT) in Food, Drink and Milk. Submission by Guinness UDV. 2<sup>nd</sup> draft dated 2001-12-07.
- Best Available Technique in Beer Production. May 2001. Submission by Deutscher Brauer-Band E. V.
- IPPC in relation to breweries. 2<sup>nd</sup> draft. November 2001. Submission by Central Brouwerij Kantoor (Dutch Brewers Association).
- World-wide benchmark for energy efficiency in the brewing industry. Brauwelt International 2002/II.
- Brewery Wastewater. EBC Manual of Good Practice. In print.
- Technology Brewing and Malting, International edition. Wolfgang Kunze. English translation of the 7<sup>th</sup> revised edition of Technologie Brauer und Mälzer.